

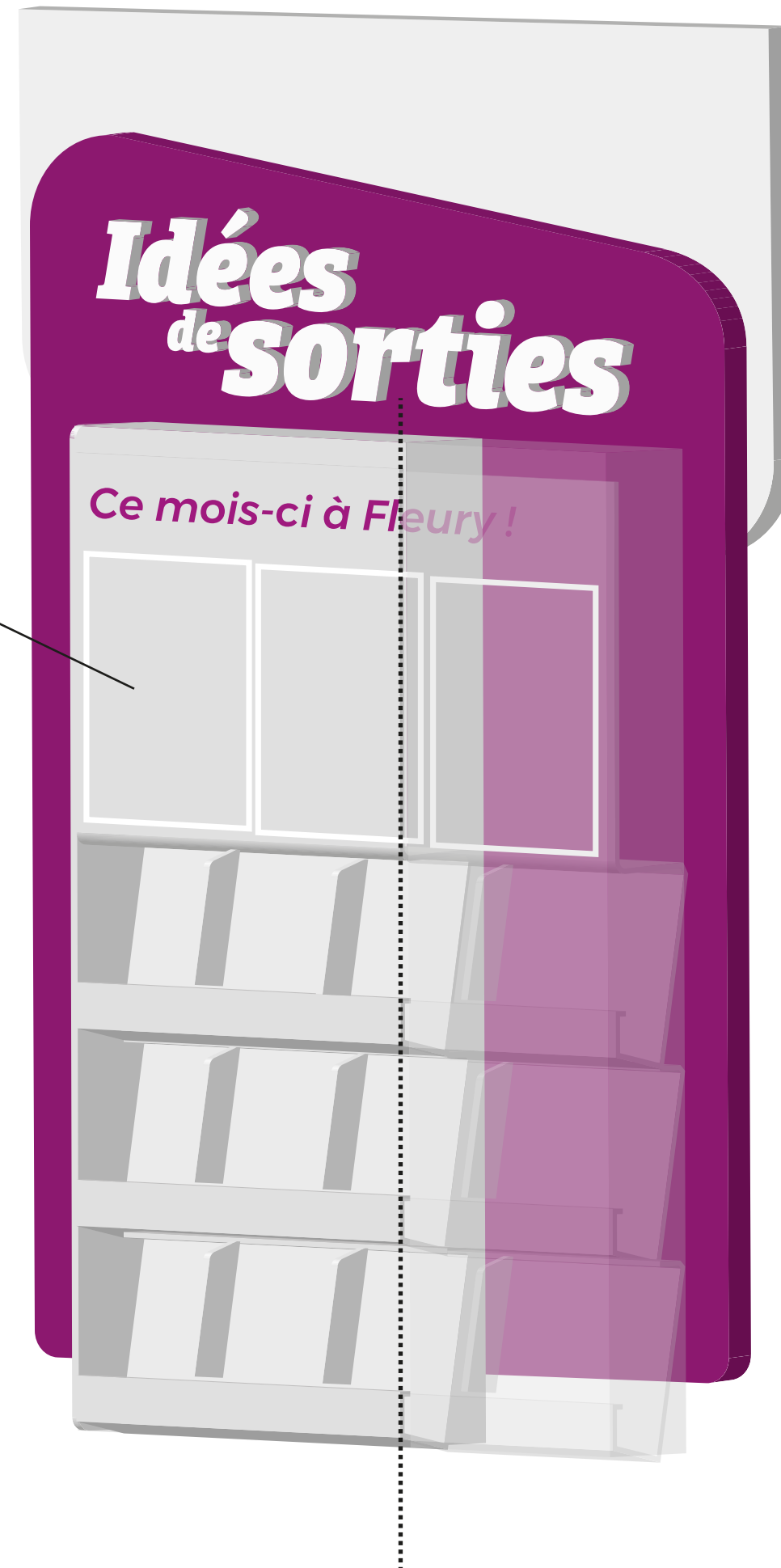

Porte affiche plastifié magnétique ou electro static  
Format A3

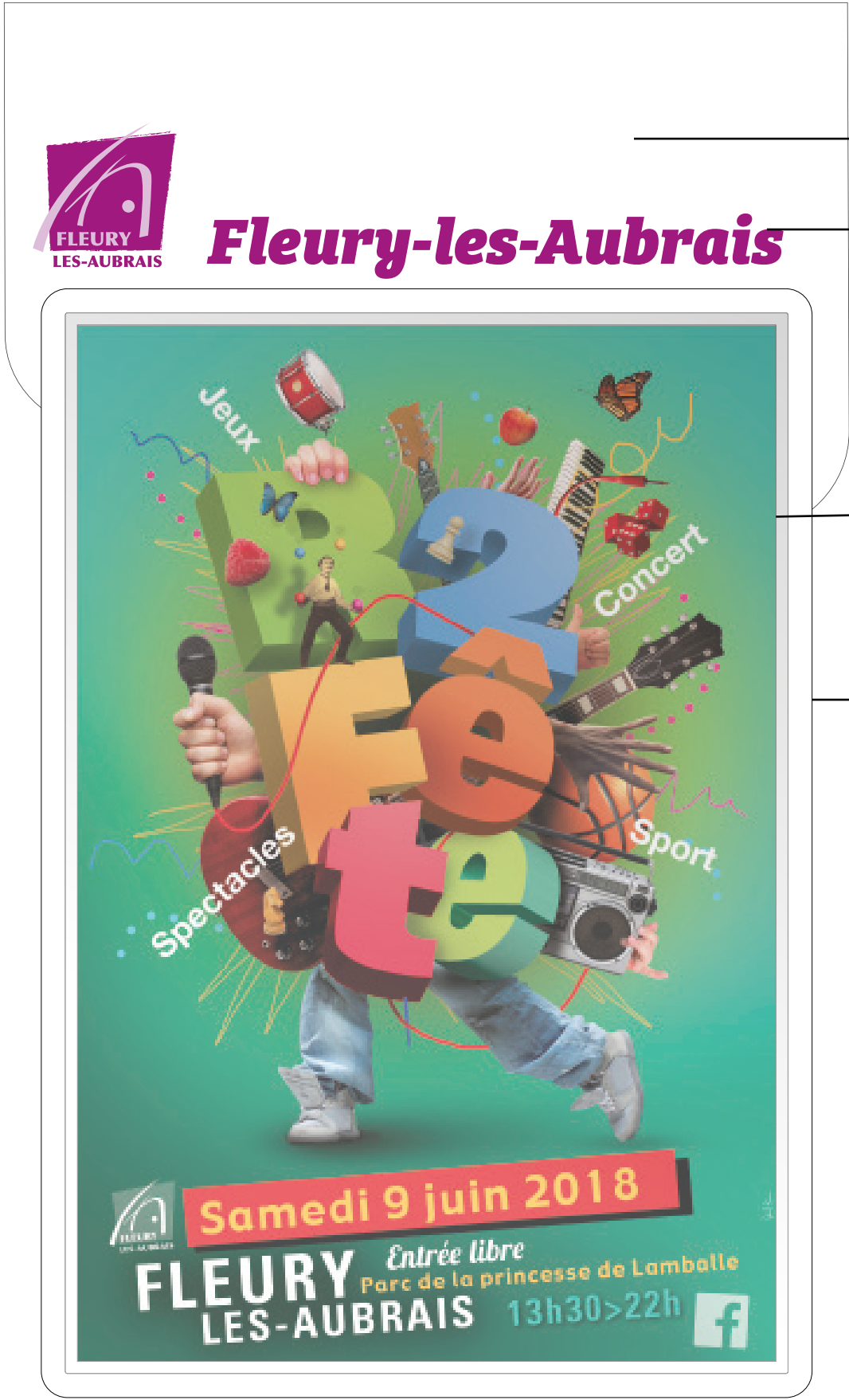

ech : 1/10e



cadre

Adhésifs

cache intérieur blanc à l'arrière de la vitre (adhésif)

coffre à ouverture par le bas ou le côté.

Bande magnétique sur la longueur pour fixer le haut de l'affiche.

Porte affiches 1200x1760mm

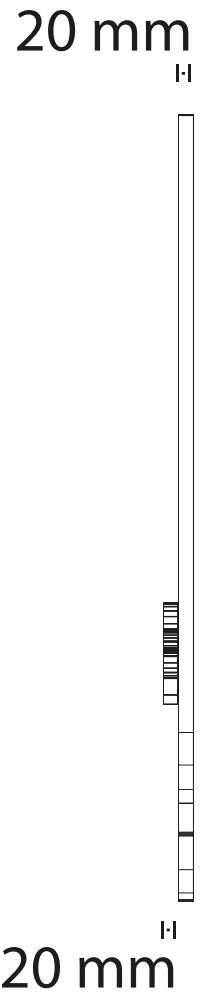
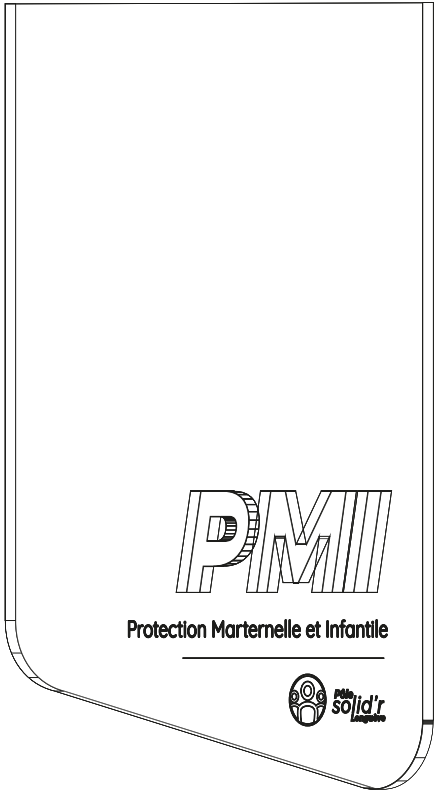
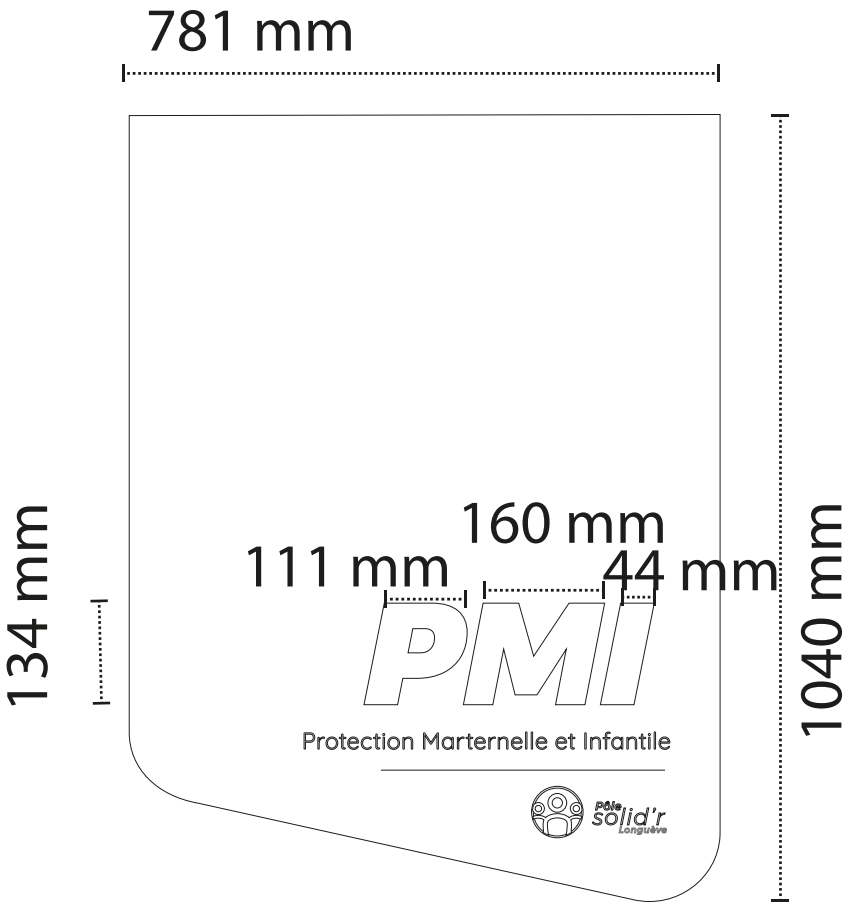

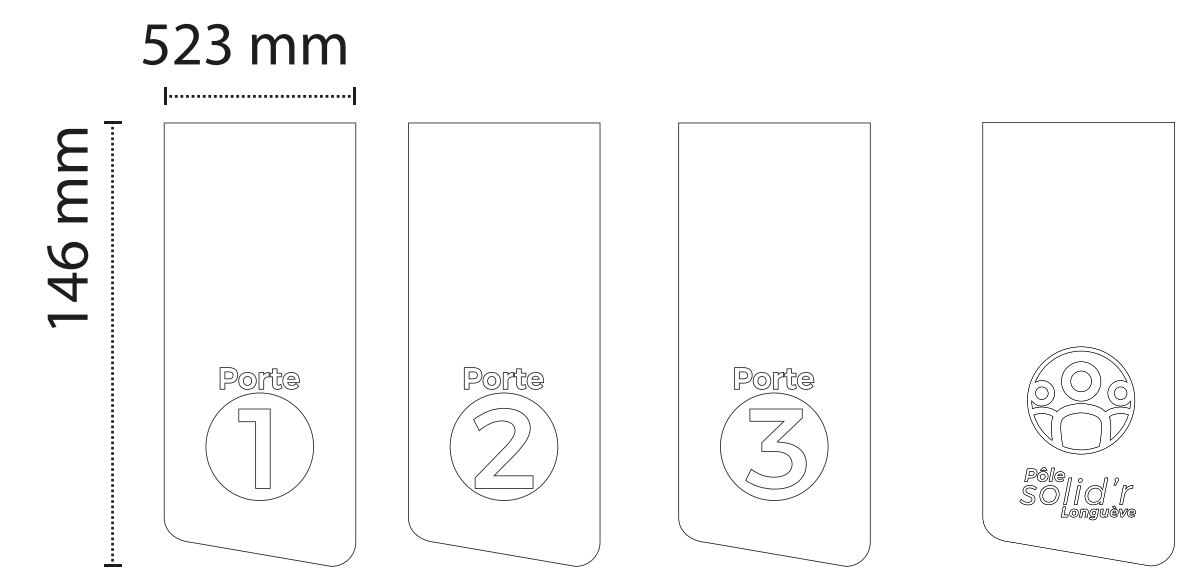
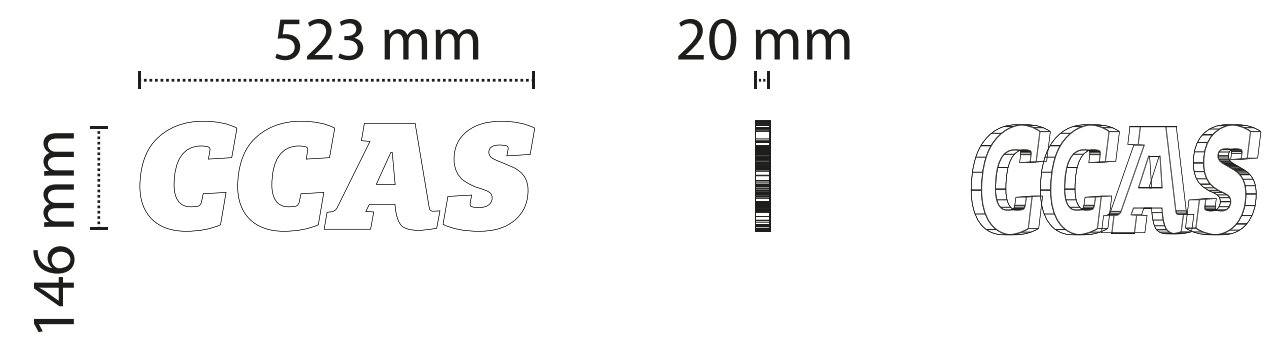
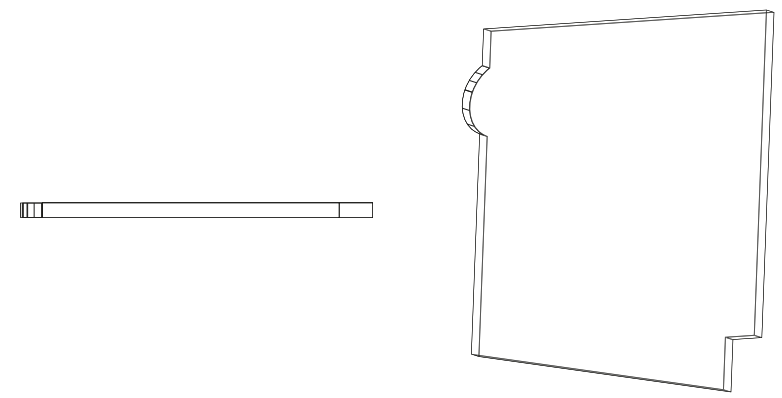
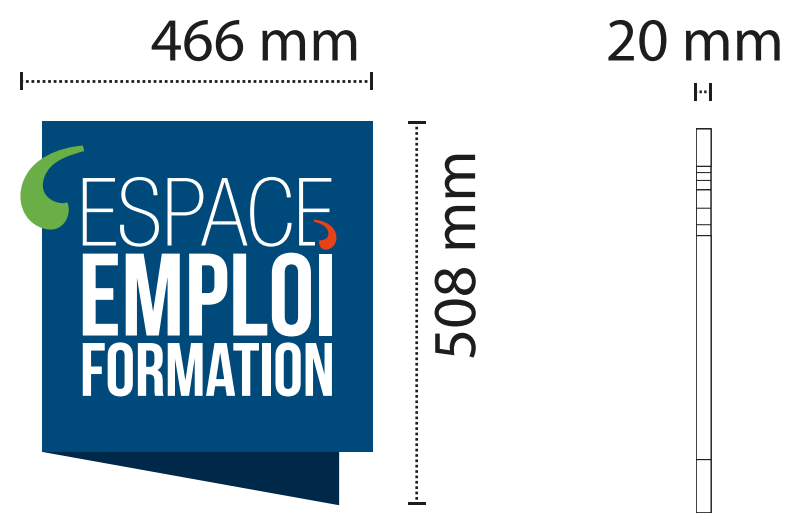



1760 mm

25000 mm

**Bienvenue !**  
**La richesse**  
**de la solidarité**  
**naît de nos différences !**



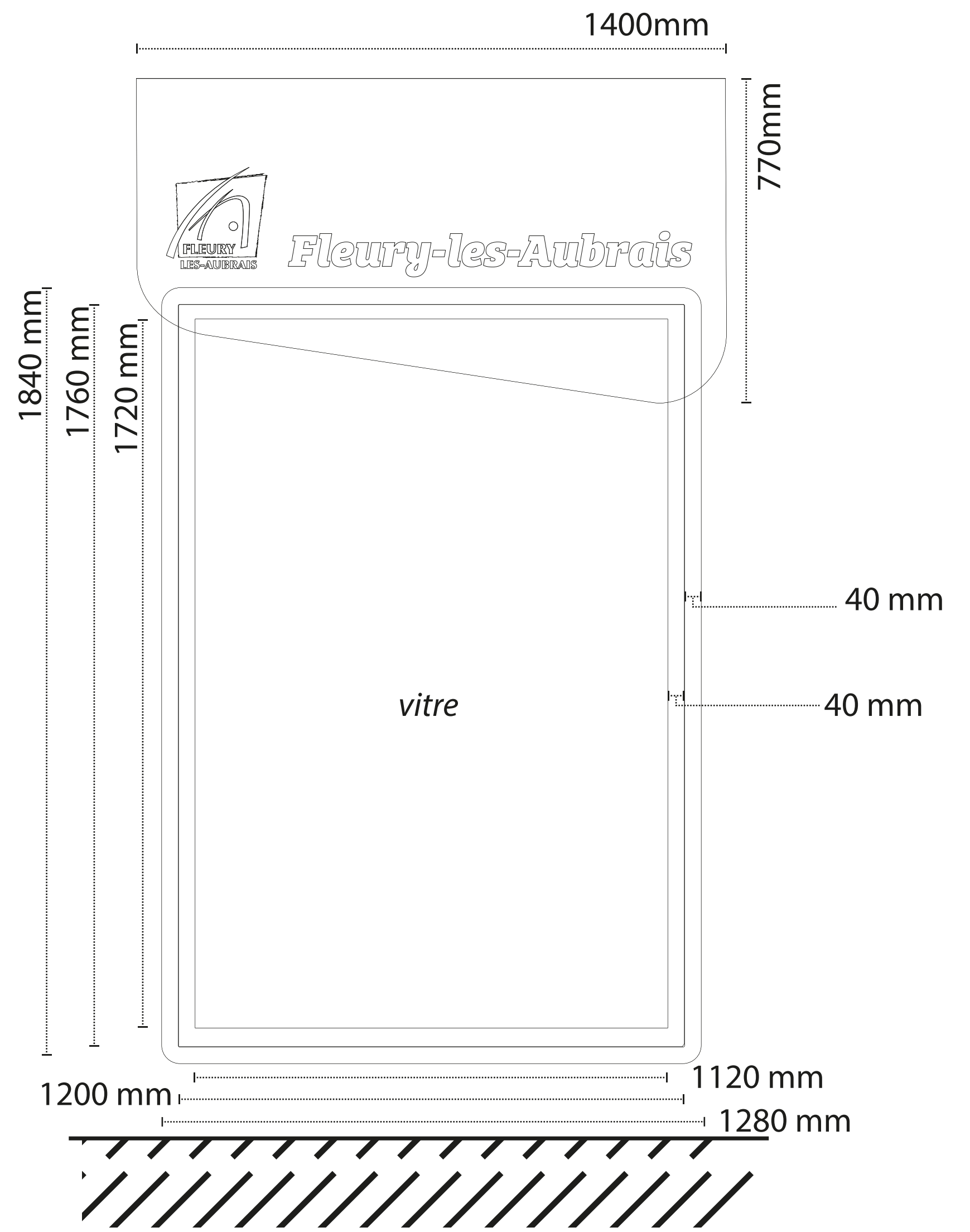
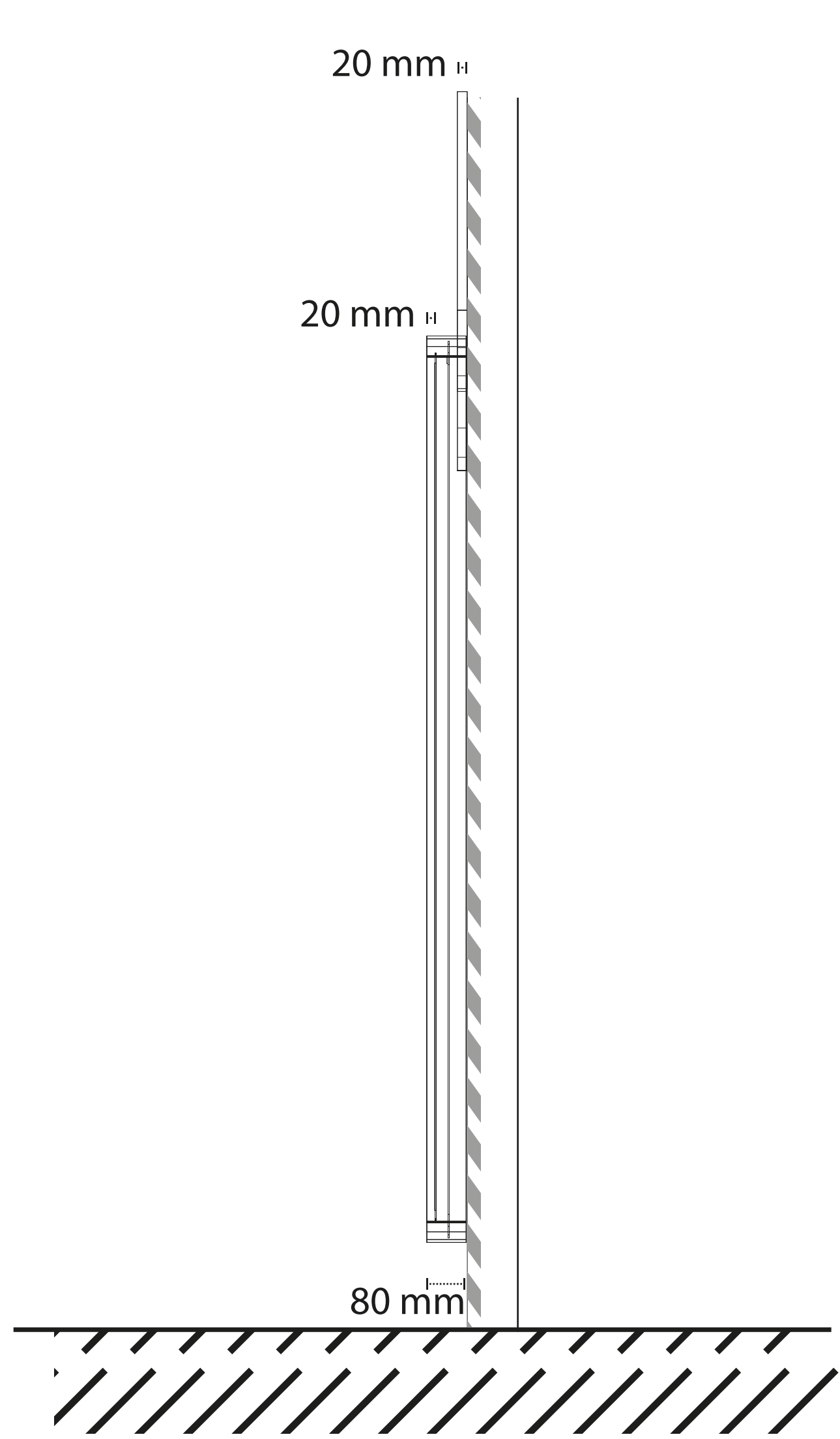

## Espace Emploi Formation

### Accueil :

Lundi :  
13h30 - 17h30

Mardi :  
9h30 - 12h30

Mercredi :  
9h30 - 12h30  
13h30 - 17h30

Jeudi :  
13h30 à 17h30

Vendredi :  
9h30 - 12h30  
13h30 - 17h30

Toutes les informations :  
Standard Hôtel de ville :  
02 38 71 93 26  
Votre ville sur :  
#neuryseaubrais.fr

☎ 02 38 71 93 26

## Centre communal d'action sociale (CCAS)

### Accueil :

Lundi / mercredi / jeudi :  
8h45 - 12h30 puis 13h45 - 17h30

Mardi :  
8h45 - 12h30

Vendredi :  
8h45 - 16h30

Toutes les informations :  
Standard Hôtel de ville :  
02 38 71 93 26  
Votre ville sur :  
#neuryseaubrais.fr

☎ 02 38 71 93 42

## Protection maternelle et infantile (PMI)

### Accueil :

Lundi / mercredi / jeudi :  
8h45 - 12h30 puis 13h45 - 17h30

Mardi :  
8h45 - 12h30

Vendredi :  
8h45 - 16h30

Toutes les informations :  
Standard Hôtel de ville :  
02 38 71 93 26  
Votre ville sur :  
#neuryseaubrais.fr

☎ 02 38 71 93 42

630mm

20 mm

## Espace Emploi Formation

### Accueil :

Lundi :  
13h30 - 17h30

Mardi :  
9h30 - 12h30

Mercredi :  
9h30 - 12h30  
13h30 - 17h30

Jeudi :  
13h30 à 17h30

Vendredi :  
9h30 - 12h30  
13h30 - 17h30

Toutes les informations :  
Standard Hôtel de ville :  
02 38 71 93 26  
Votre ville sur :  
#neuryseaubrais.fr

☎ 02 38 71 93 26

1340 mm

# Bienvenue !

La **richesse** de la **solidarité** naît de nos **différences** !

922 mm

Bienvenue !

135 mm

2375 mm

La richesse de la solidarité naît de nos différences !

85 mm

20 mm



Bienvenue !

La richesse de la solidarité naît de nos différences !

Ø 310 mm



Ø 259 mm



Ø 457mm



Ø 208 mm



Ø 286 mm



Ø 311 mm



Ø 544 mm



10 mm  
H

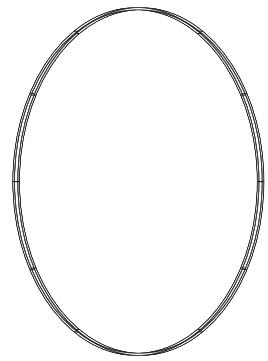
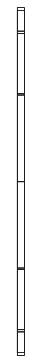
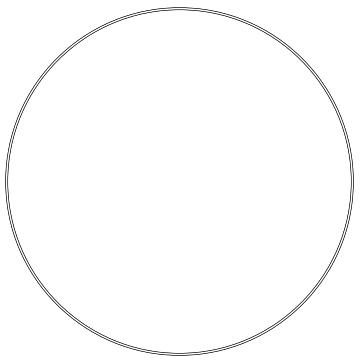



153 mm  
149 mm  
ACCÈS  
RÉSERVÉ

**Bienvenue**  
Entrée sans frapper

59 mm  
370 mm  
Bienvenue

36 mm  
370 mm  
Entrée sans frapper

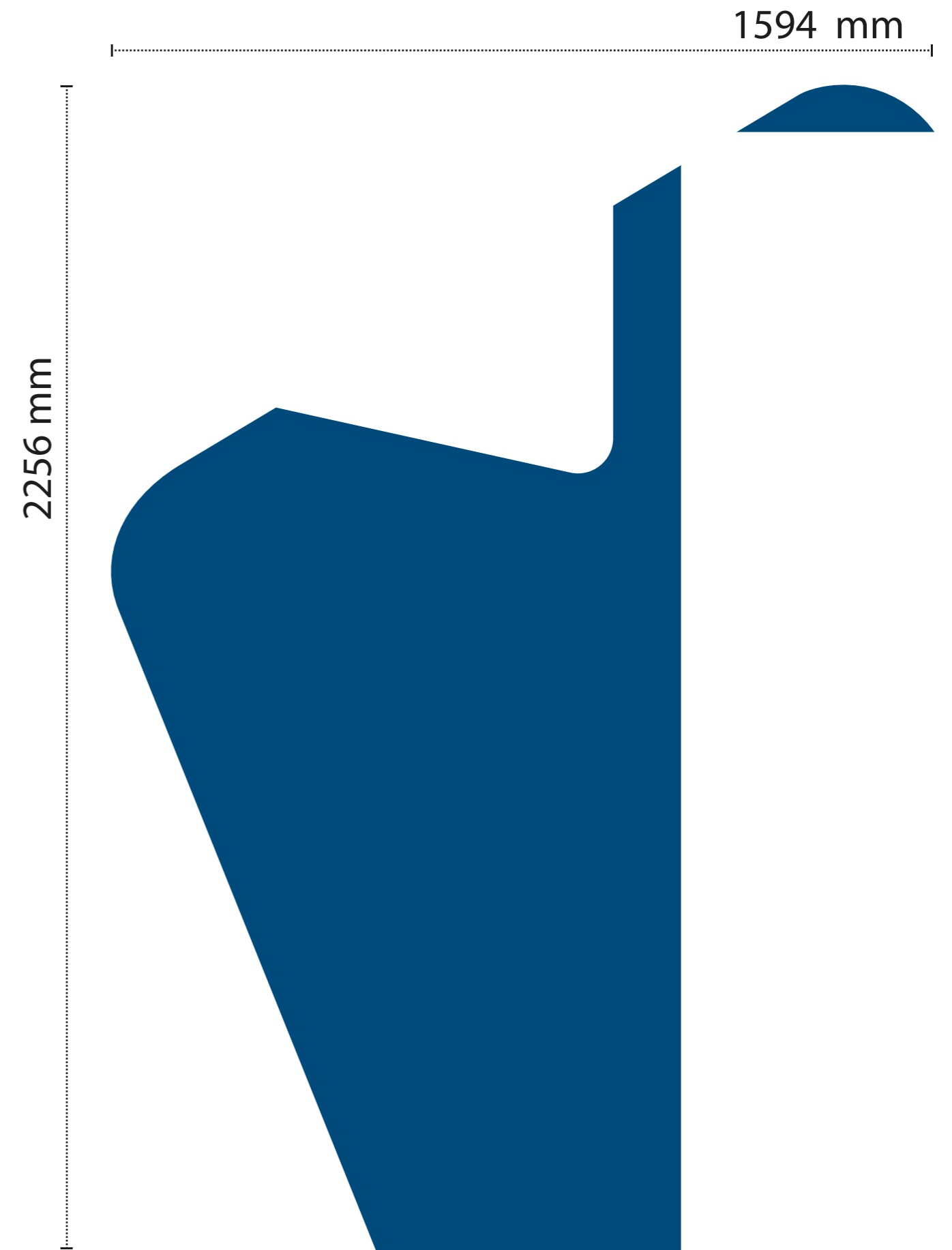
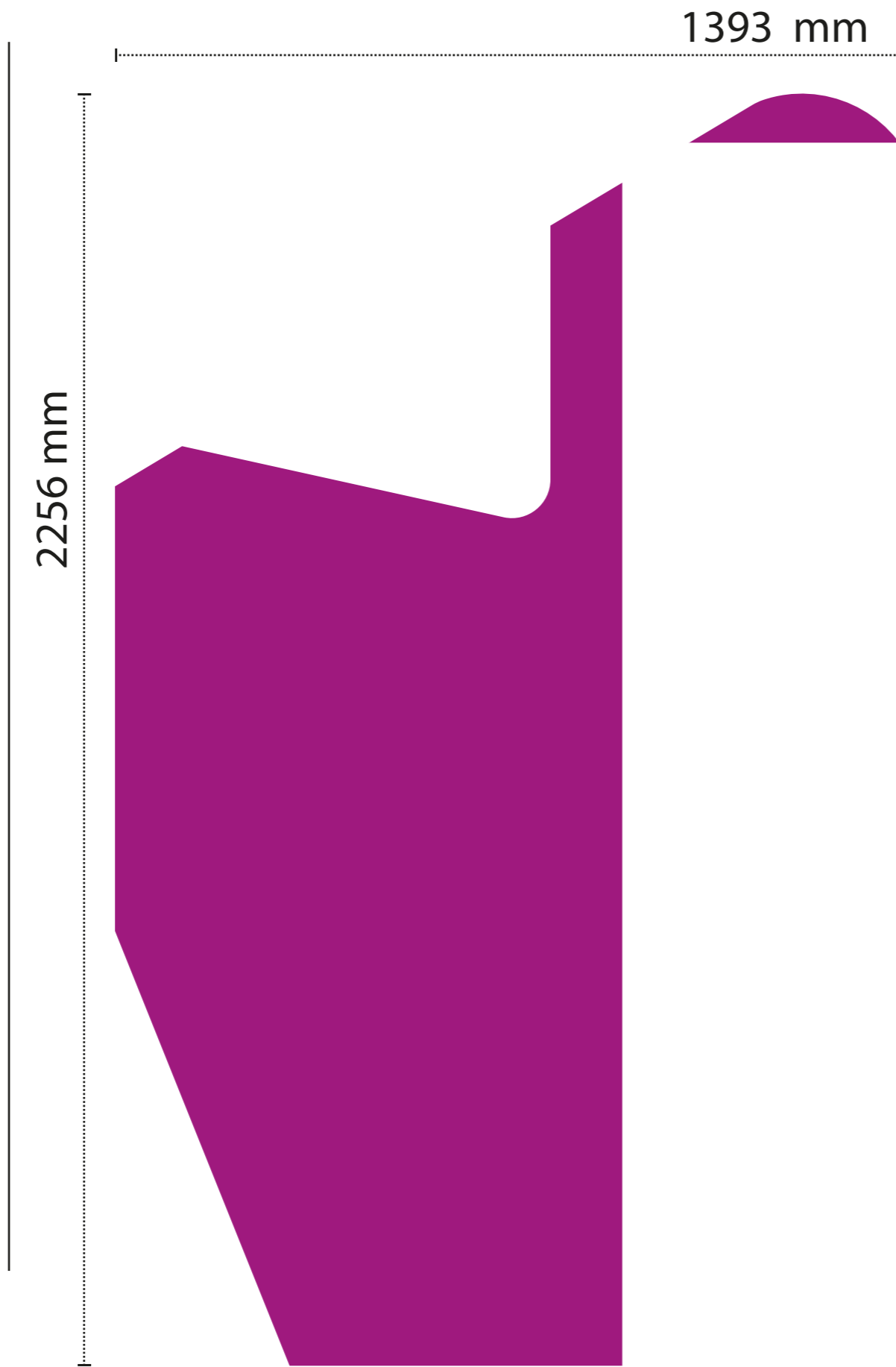

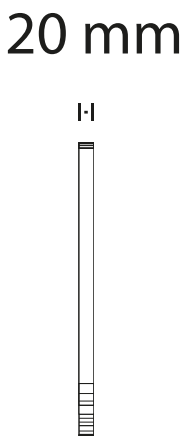
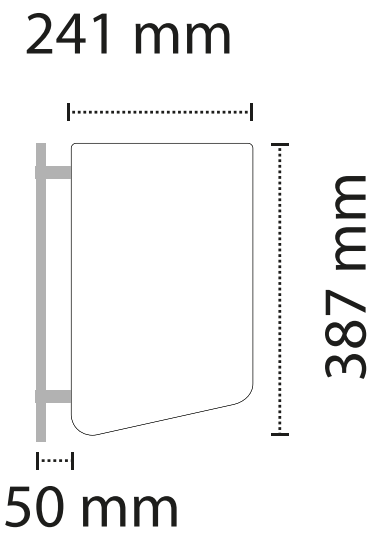
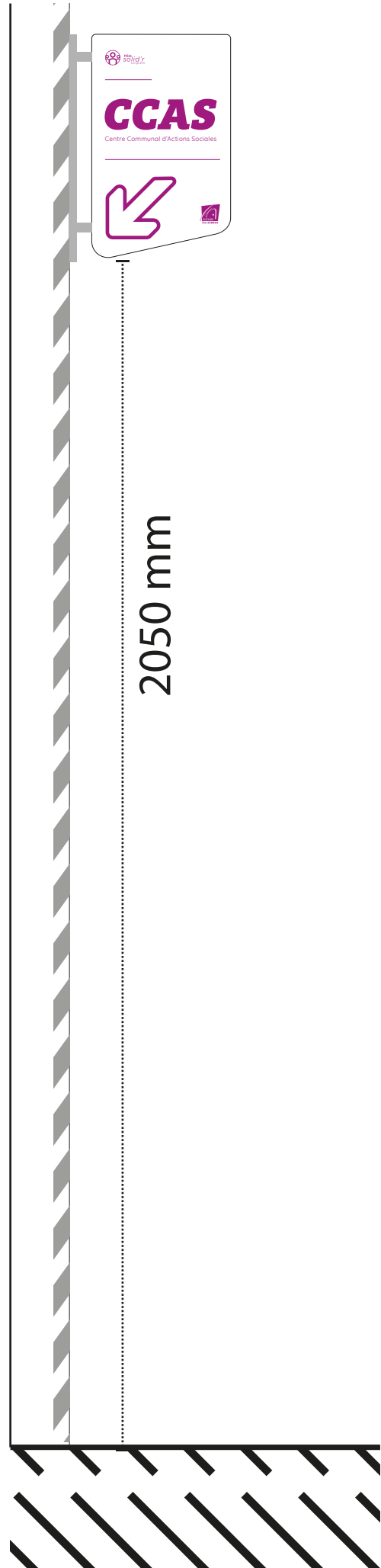
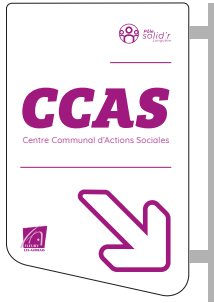
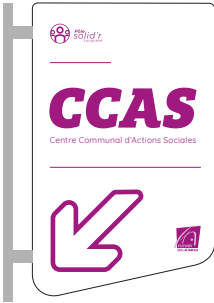

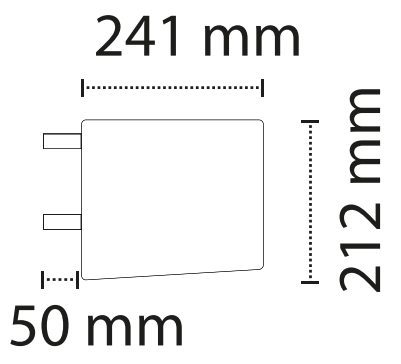
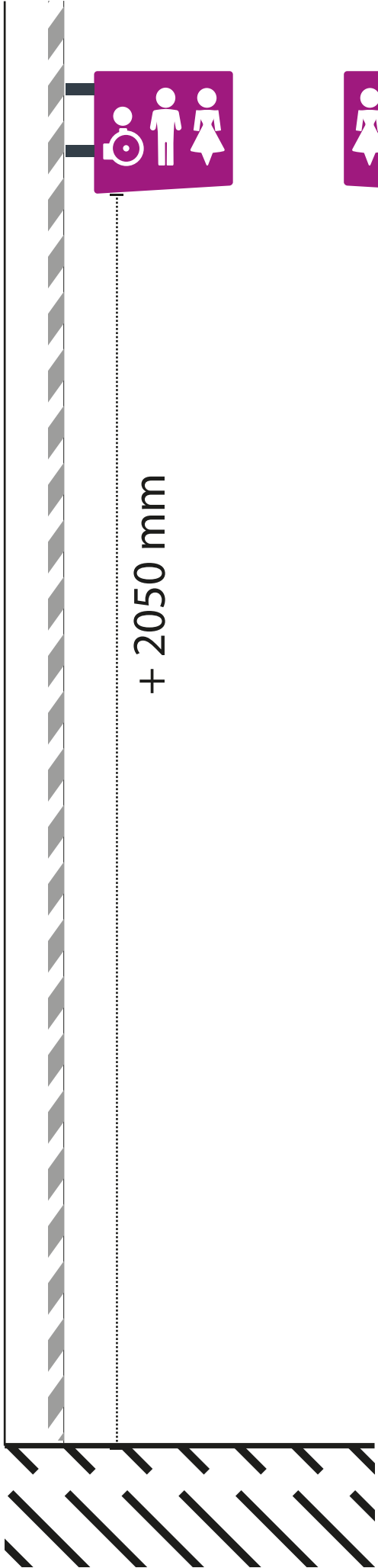

20 mm

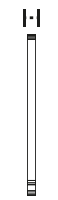

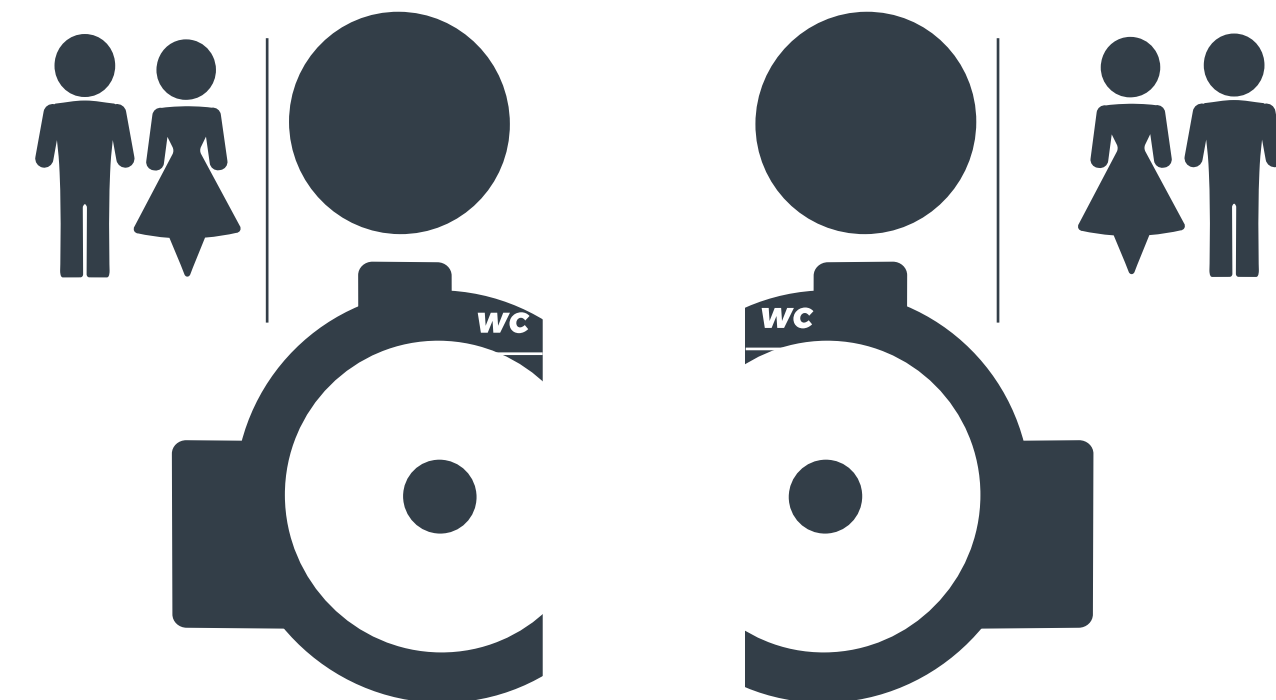
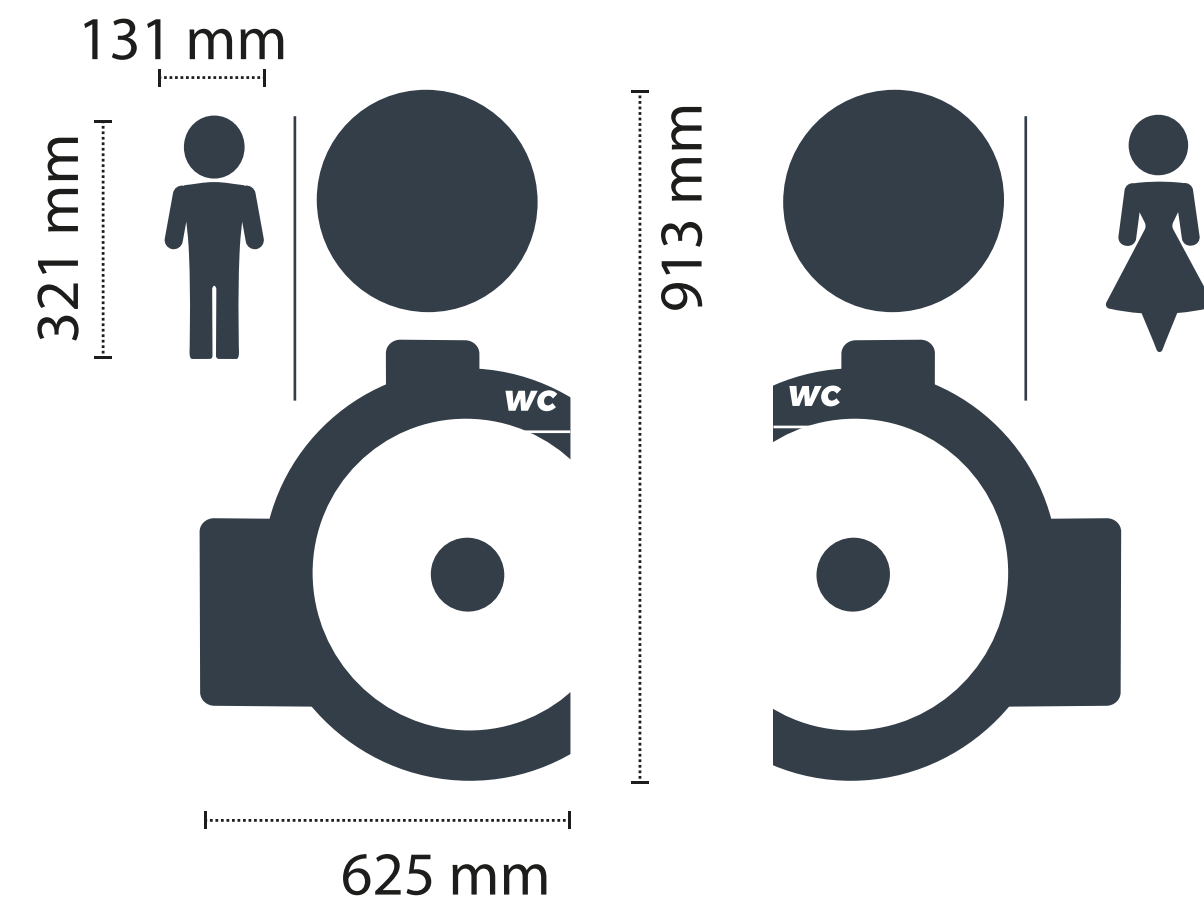
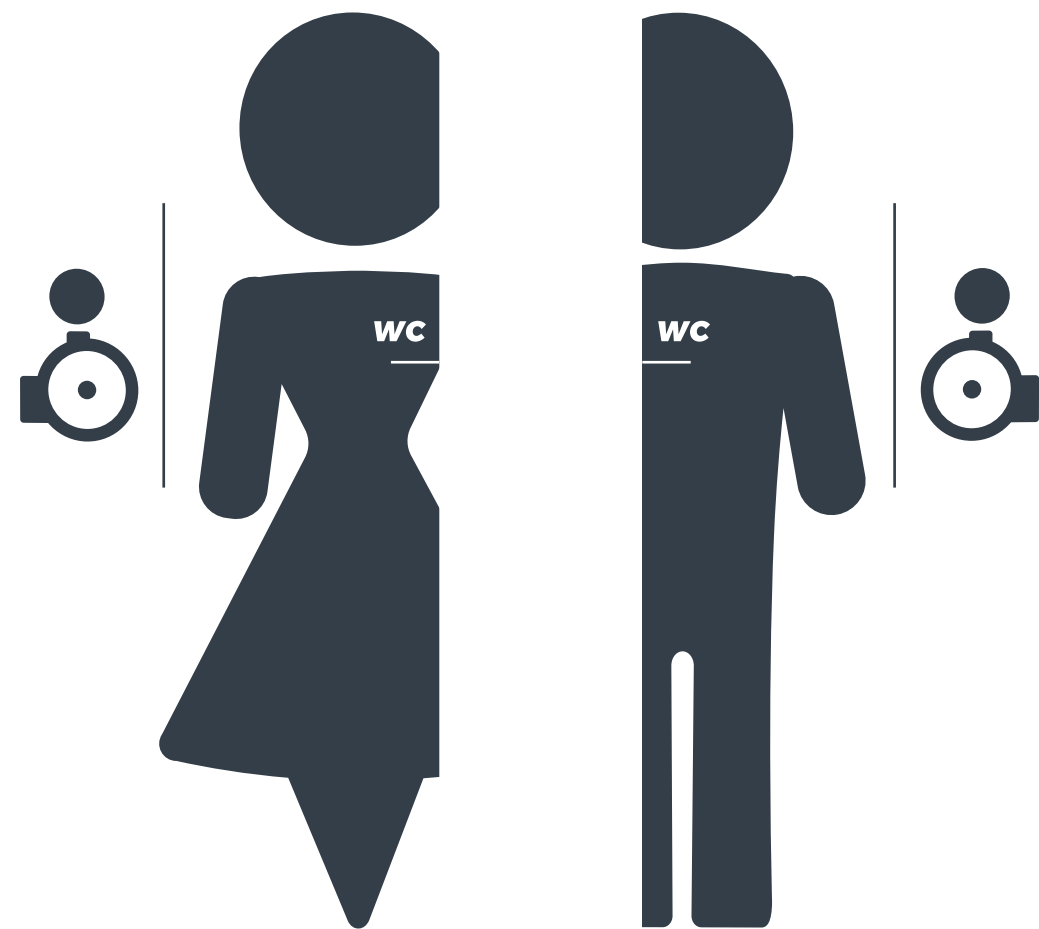
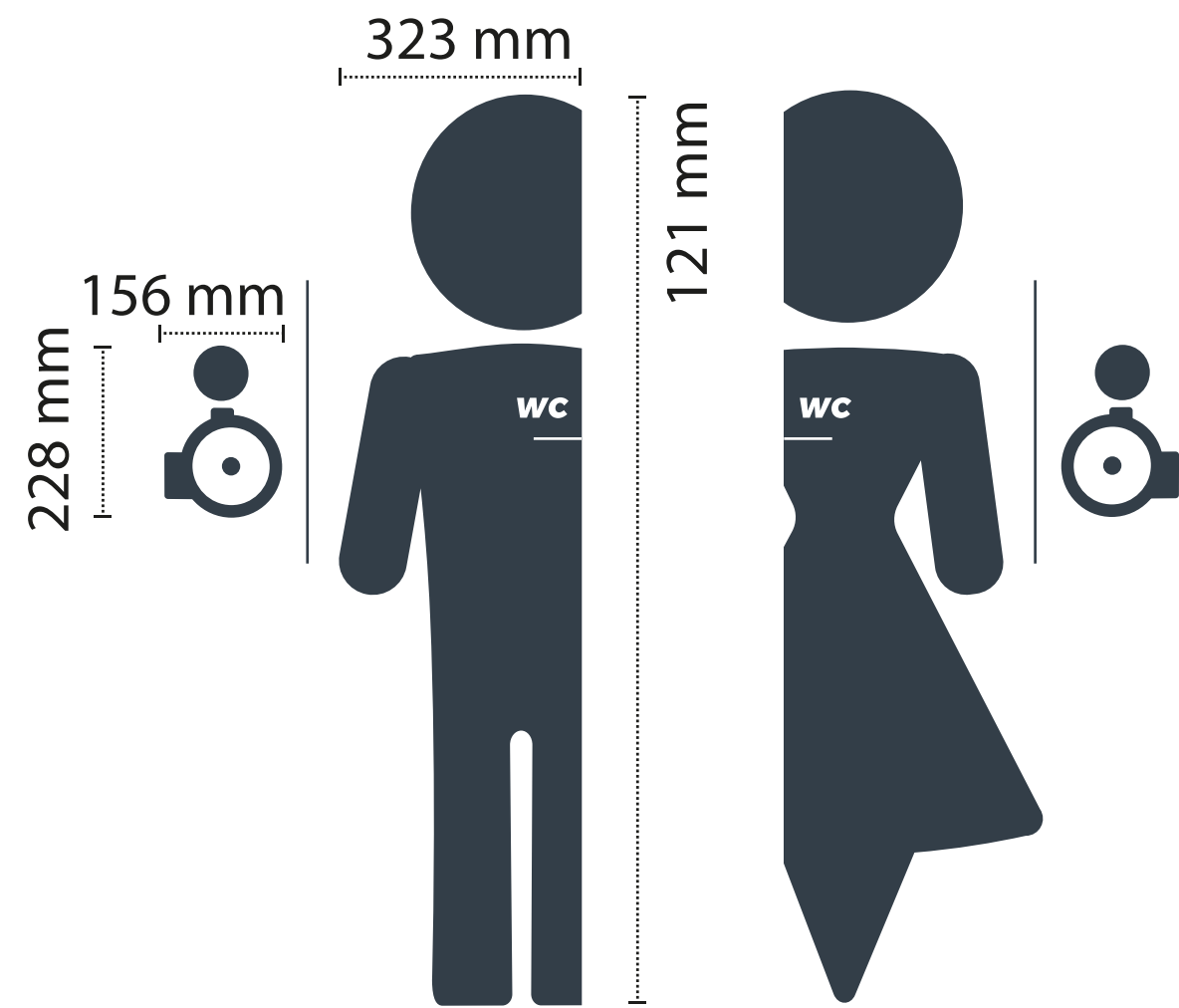
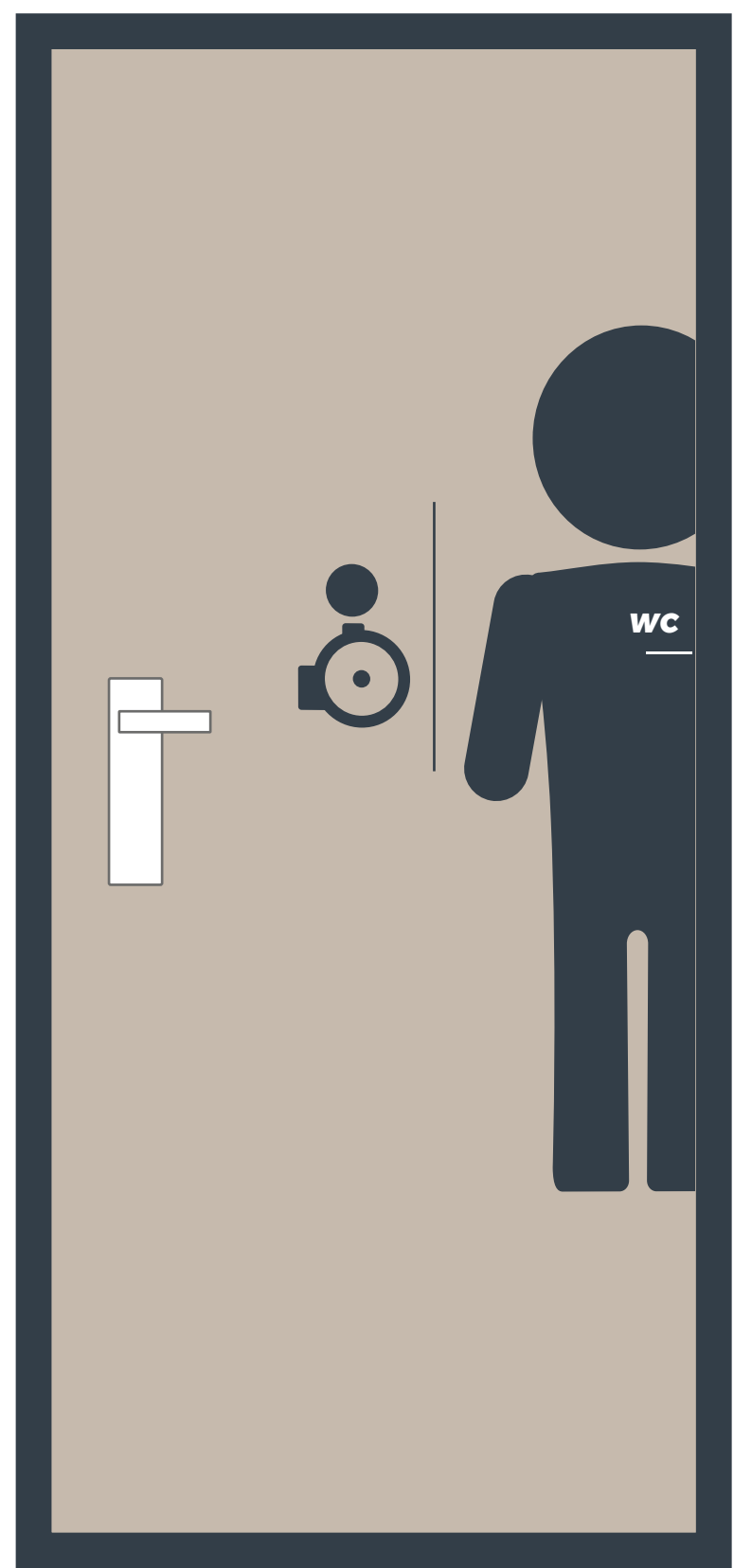

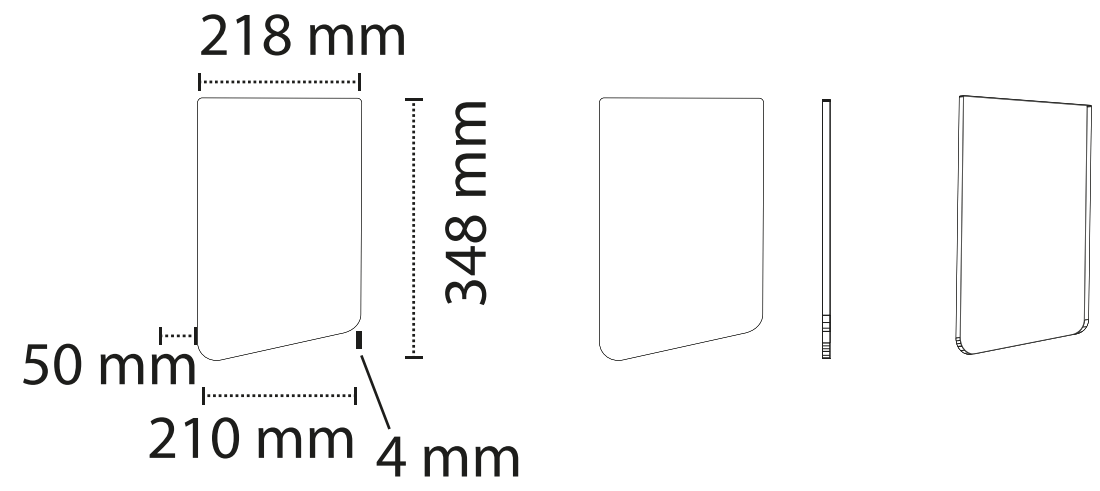
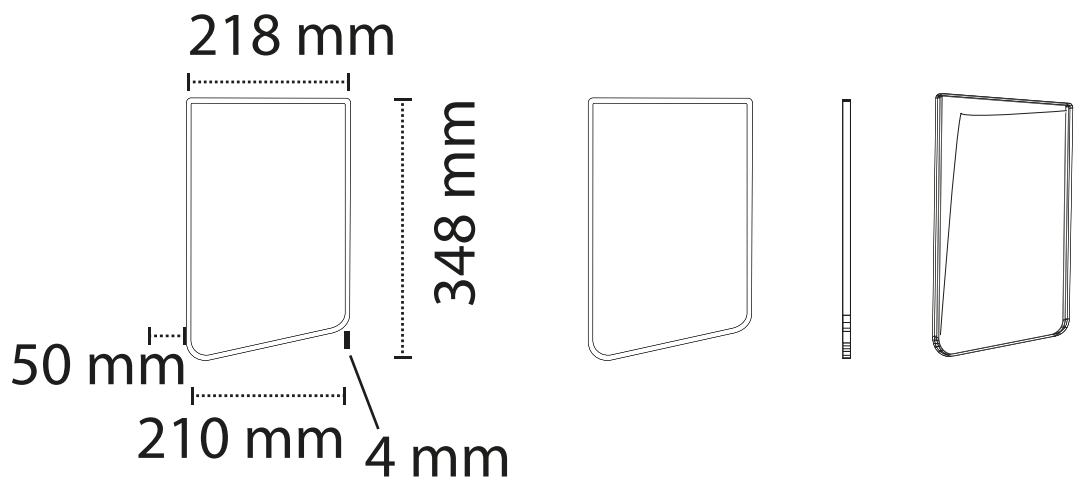

1,5 mm  
H

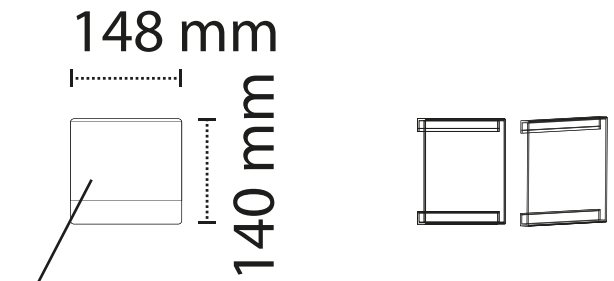

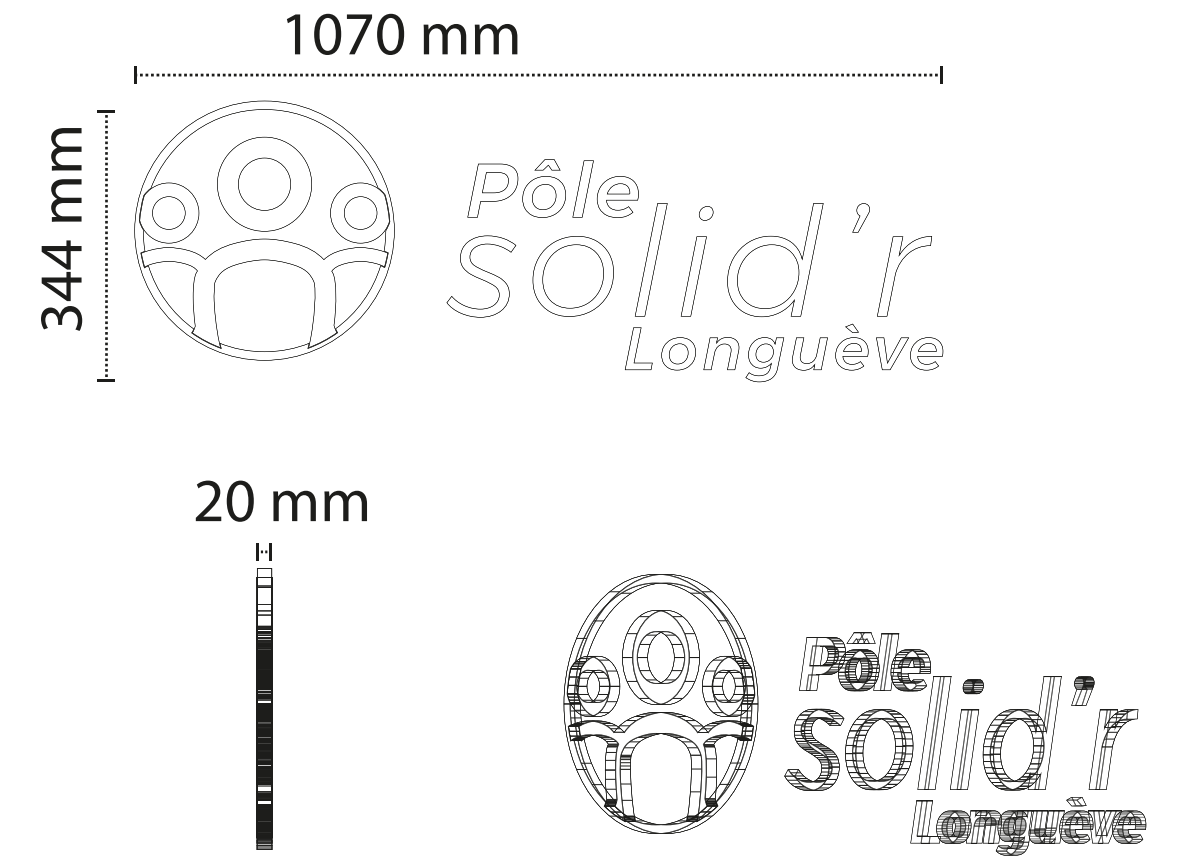
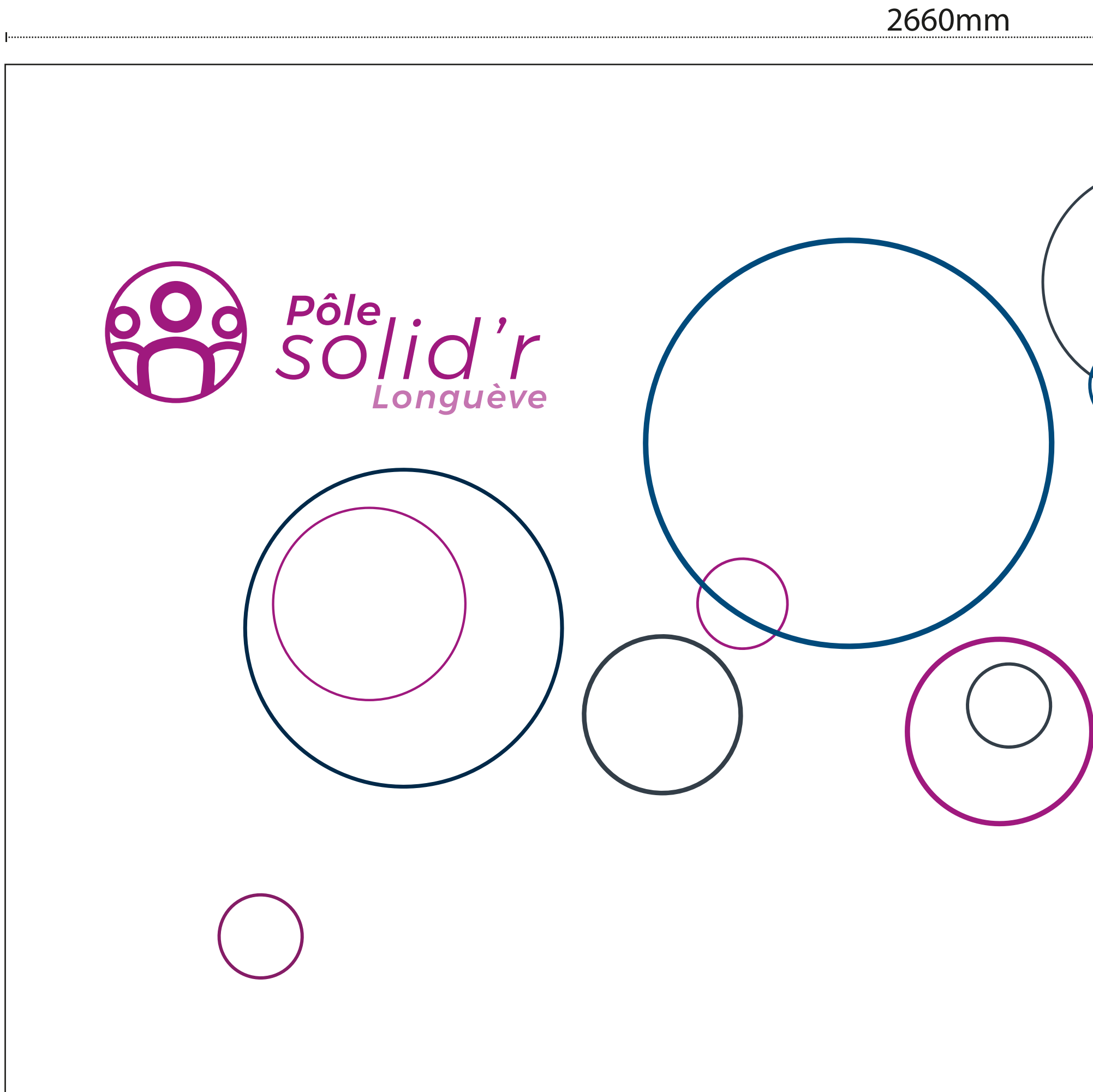

3056 mm

2500 mm

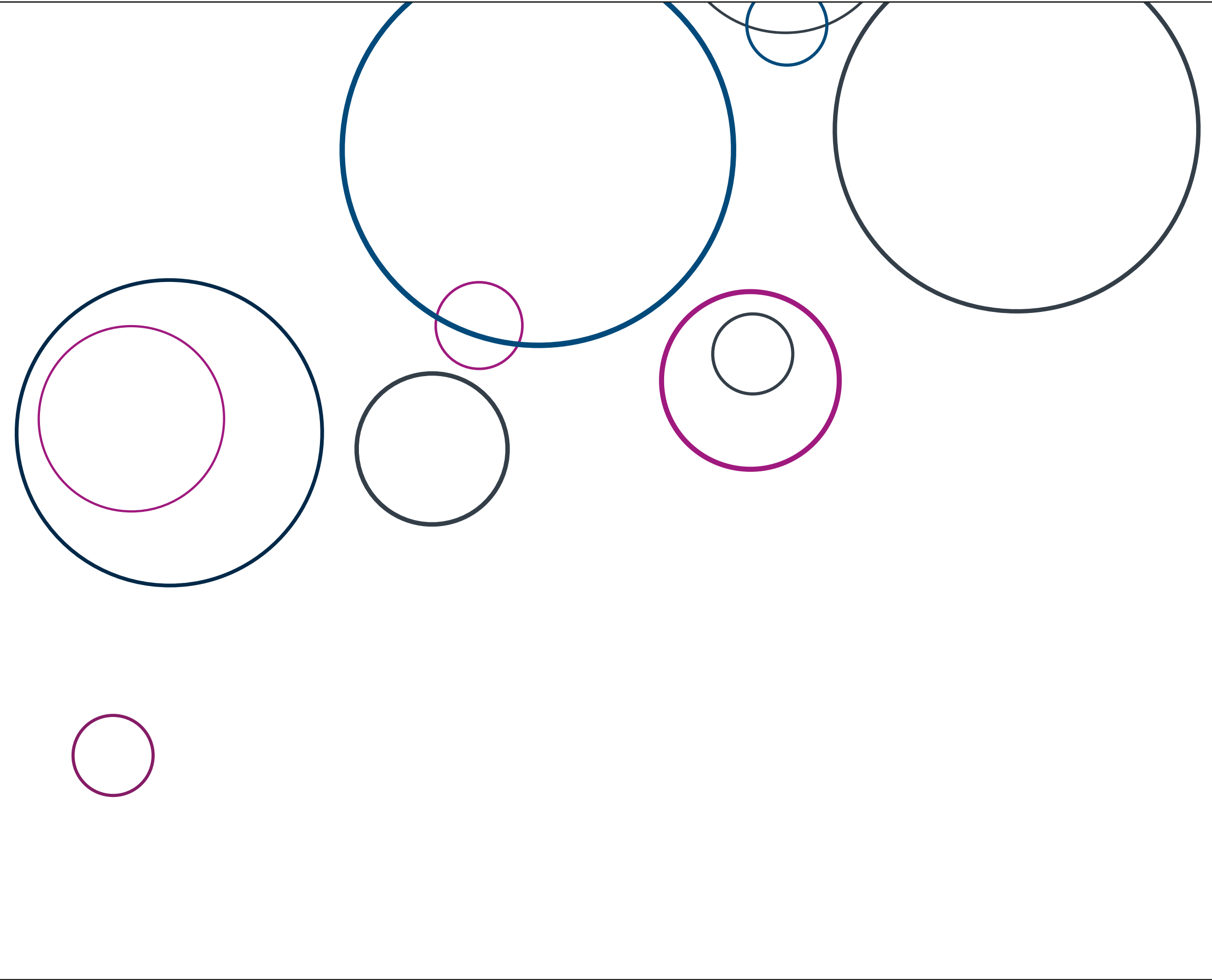

adhésifs mauve

**Infos & documents**

*Dispositifs et événements*

Flyer Flyer Flyer Flyer

**Pôle solid'r**  
Longuève

adhésifs blancs

**Bienvenue!**

**i Informations** Les services présents au sein du Pôle solid'r

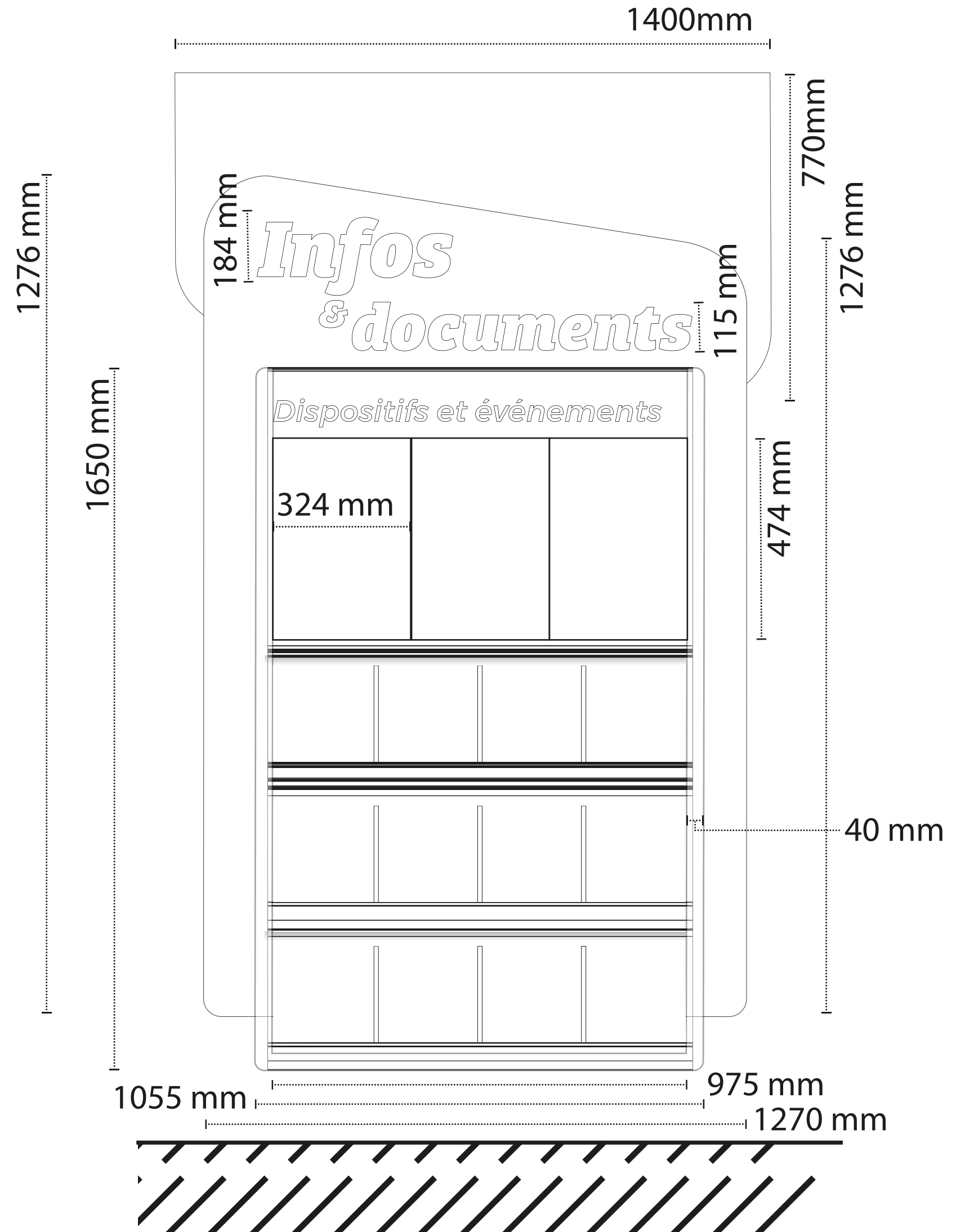
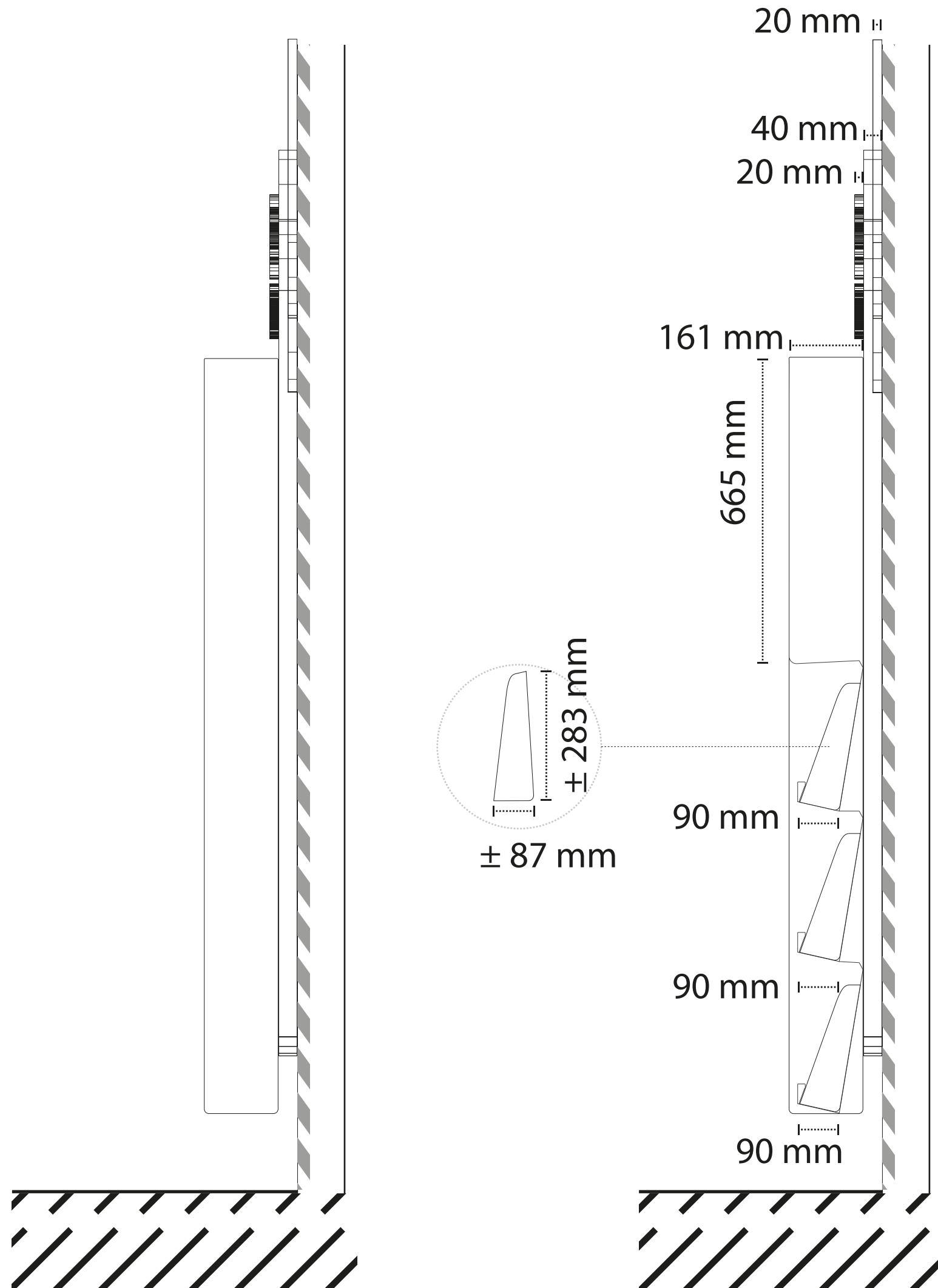

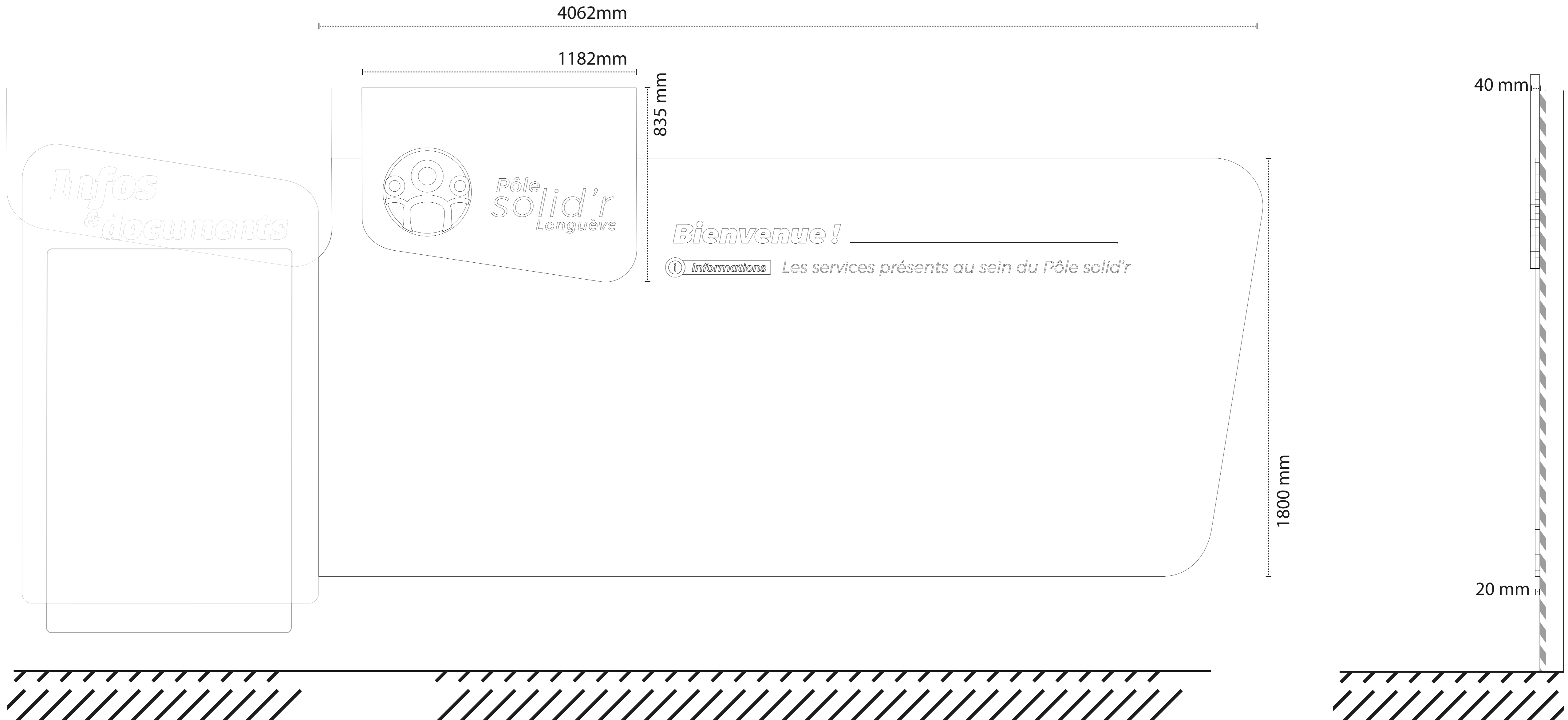

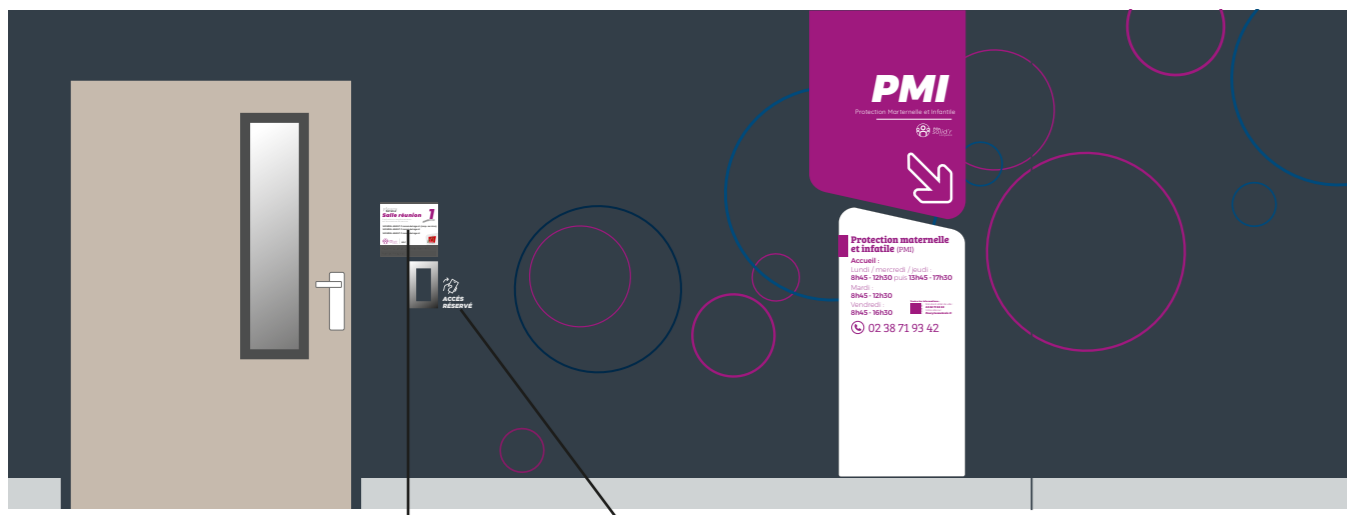

Voir plaque de porte

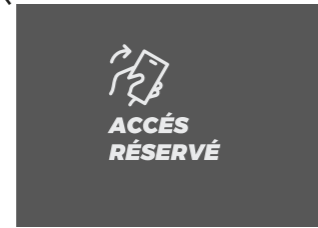

Voir adhésif mural

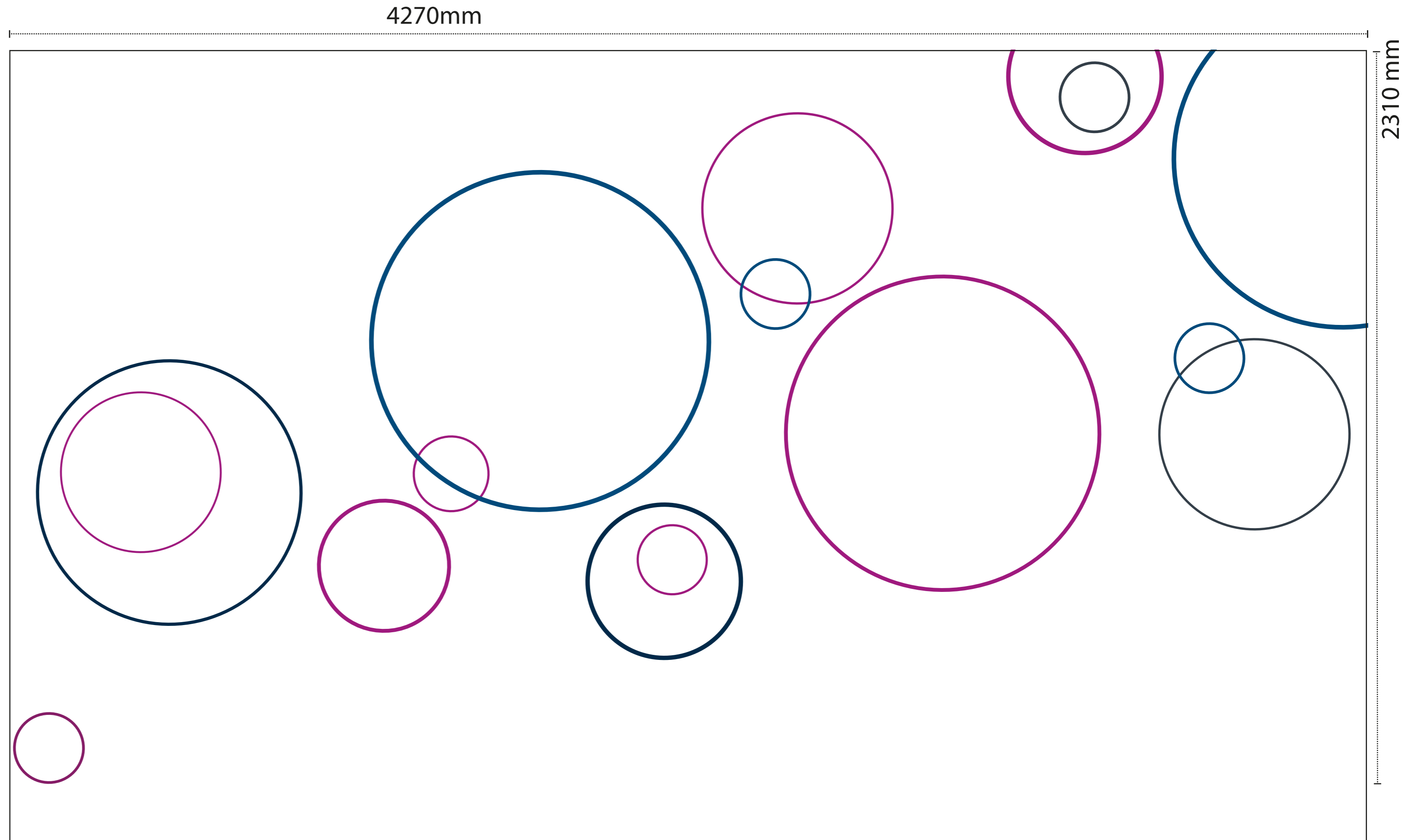



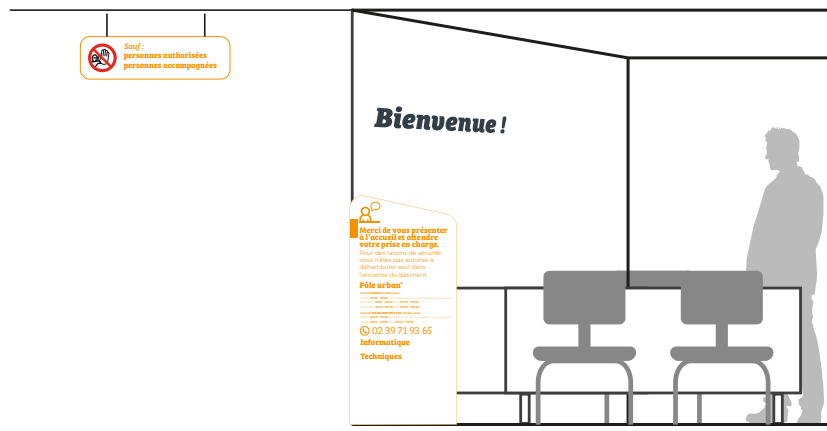

# Bienvenue !

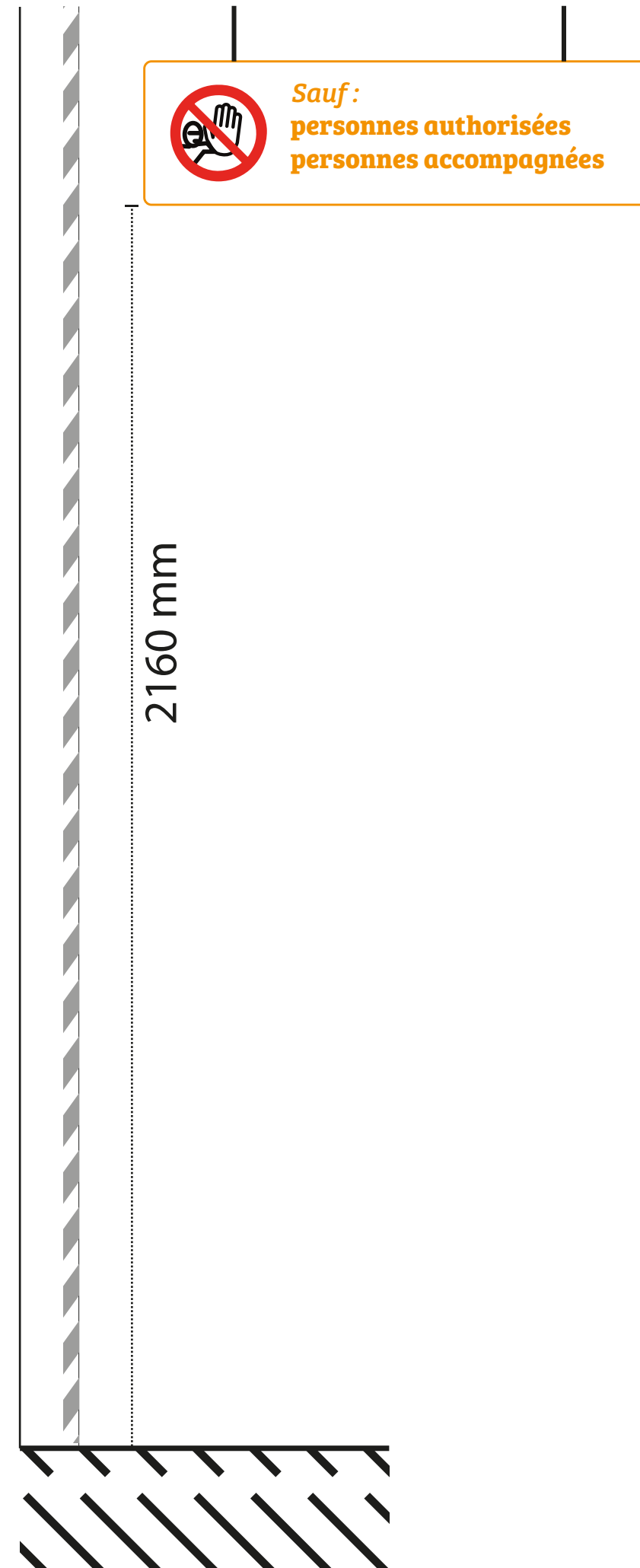
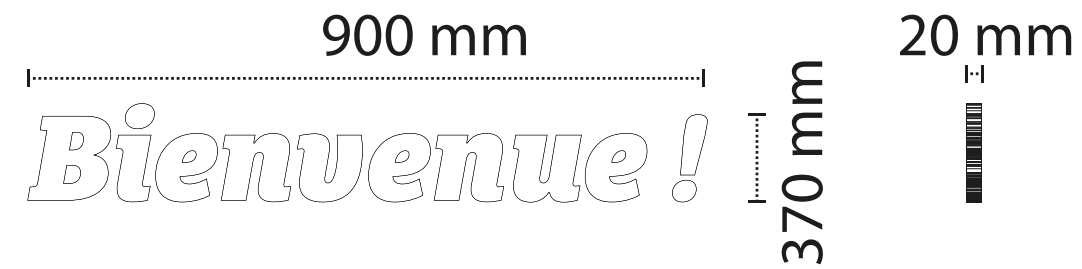

**Merci de vous présenter à l'accueil et attendre votre prise en charge.**  
 Pour des raisons de sécurité vous n'êtes pas autorisé à déhambuler seul dans l'enceinte du bâtiment.

**Pôle urban'**

**Accueil sans rendez-vous :**  
 Lundi : 8h45 - 12h30 (fermé l'après-midi, permanence téléphonique uniquement)  
 Mercredi : 8h45 - 12h30 puis 13h45 - 17h30  
 Vendredi : 8h45 - 12h30 puis 13h45 - 16h30

**Accueil uniquement sur rendez-vous :**  
 Mardi : 8h45 - 12h30 (fermé l'après-midi, permanence téléphonique uniquement)  
 Jeudi : 8h45 - 12h30 puis 13h45 - 17h30

☎ 02 39 71 93 65

**Informatique**

**Techniques**

piétement lesté rond



**Merci de vous présenter à l'accueil et attendre votre prise en charge.**  
 Pour des raisons de sécurité vous n'êtes pas autorisé à déhambuler seul dans l'enceinte du bâtiment.

**Pôle urban'**

**Accueil sans rendez-vous :**  
 Lundi : 8h45 - 12h30 (fermé l'après-midi, permanence téléphonique uniquement)  
 Mercredi : 8h45 - 12h30 puis 13h45 - 17h30  
 Vendredi : 8h45 - 12h30 puis 13h45 - 16h30

**Accueil uniquement sur rendez-vous :**  
 Mardi : 8h45 - 12h30 (fermé l'après-midi, permanence téléphonique uniquement)  
 Jeudi : 8h45 - 12h30 puis 13h45 - 17h30

☎ 02 39 71 93 65

**Informatique**

**Techniques**

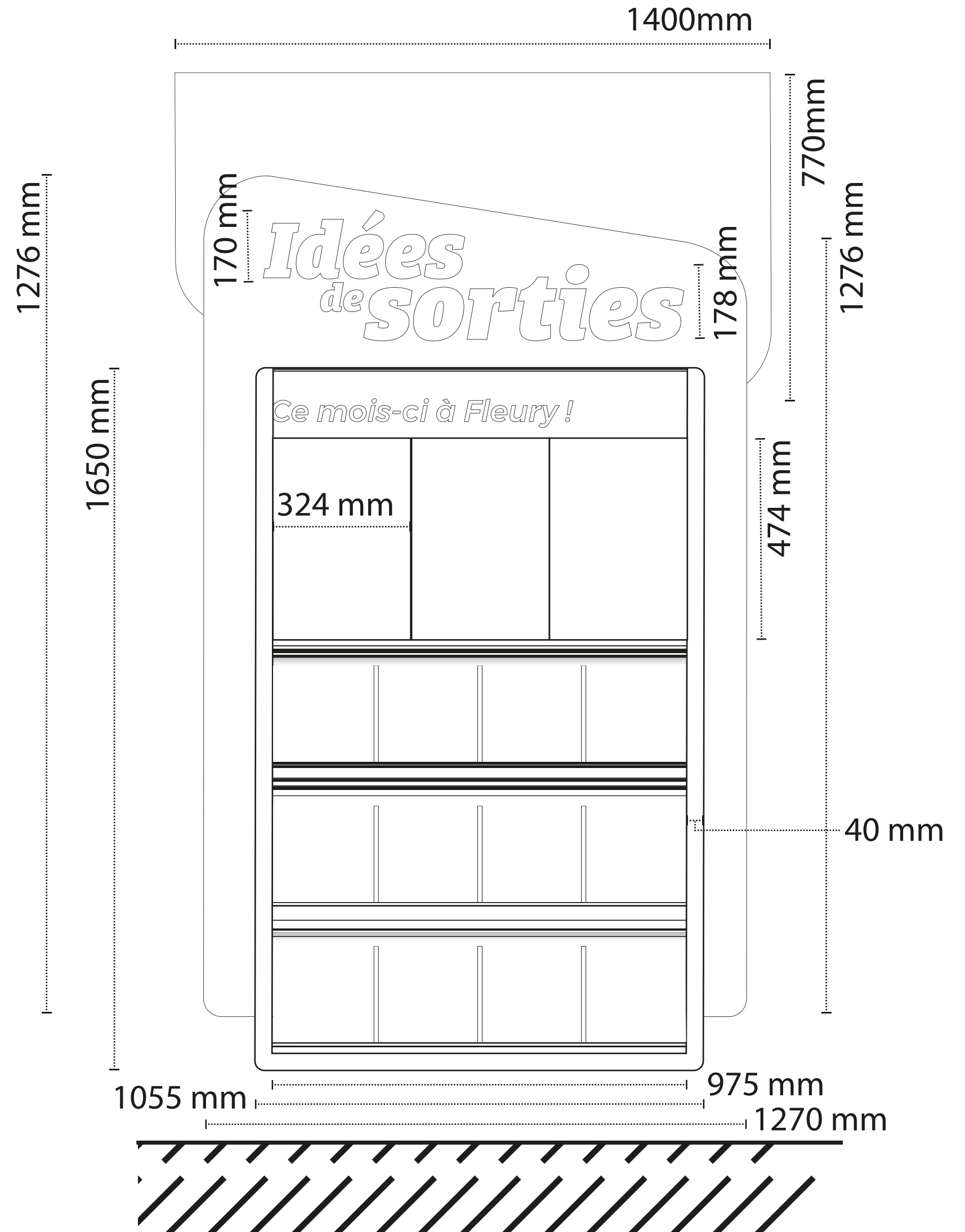
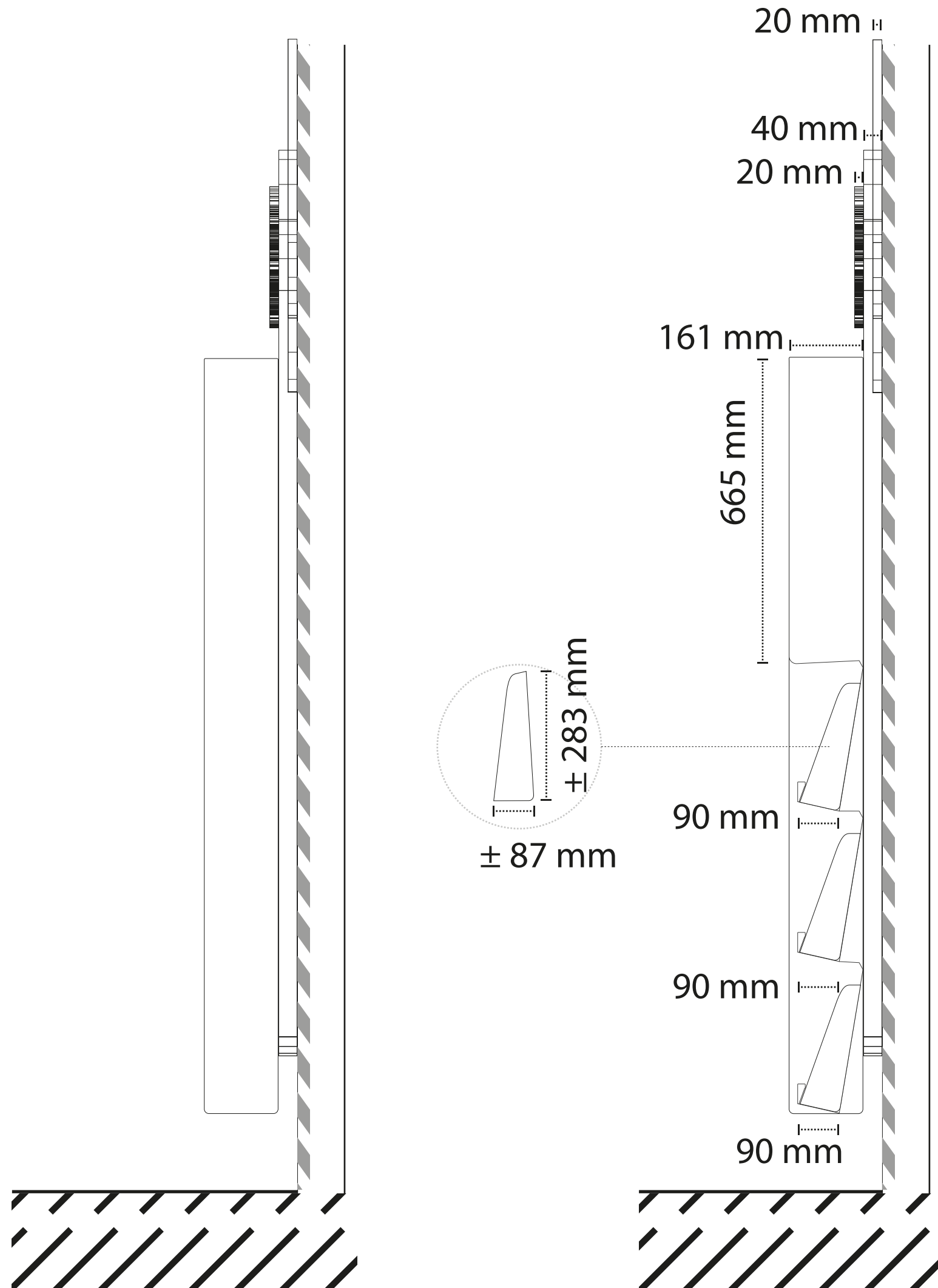

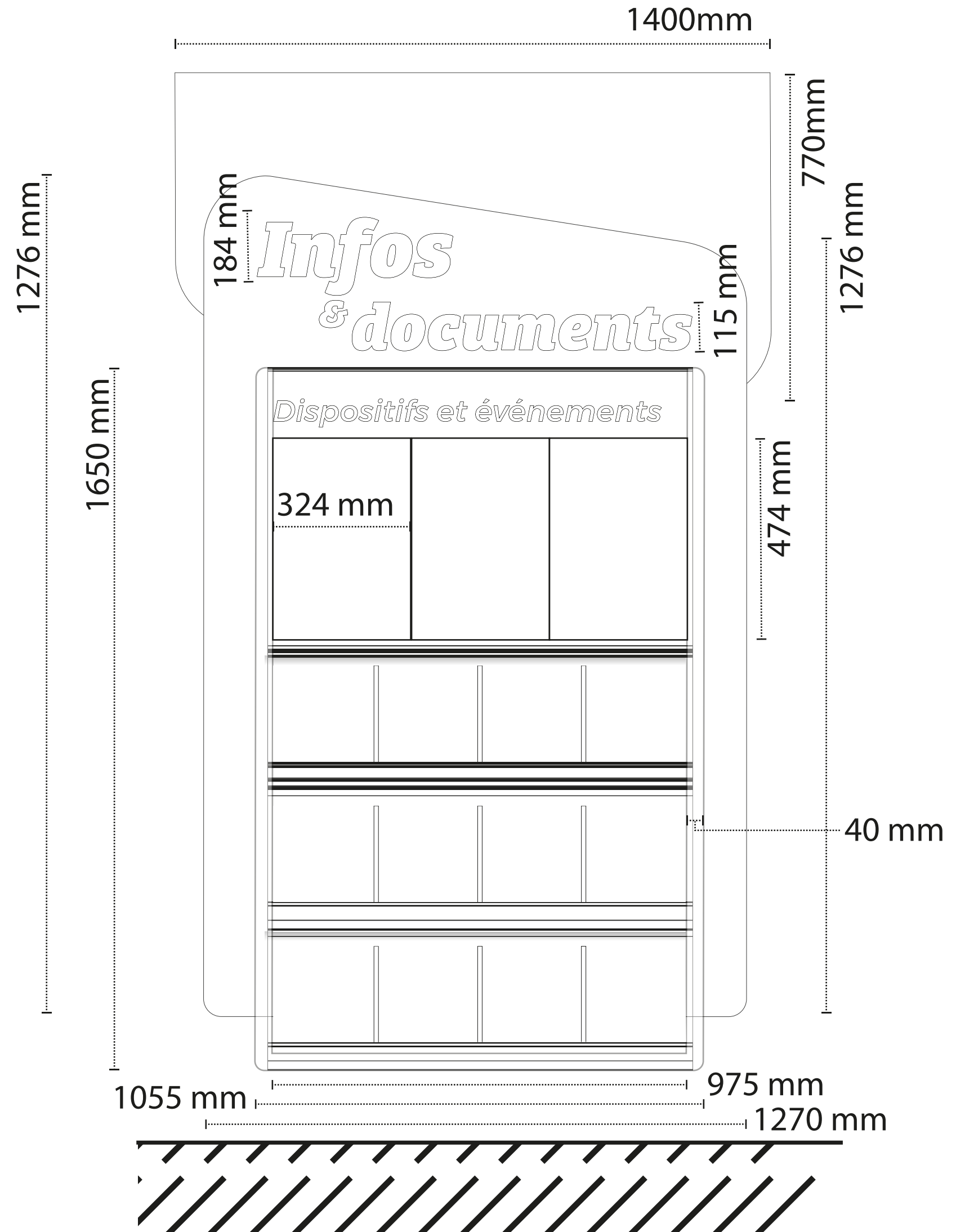
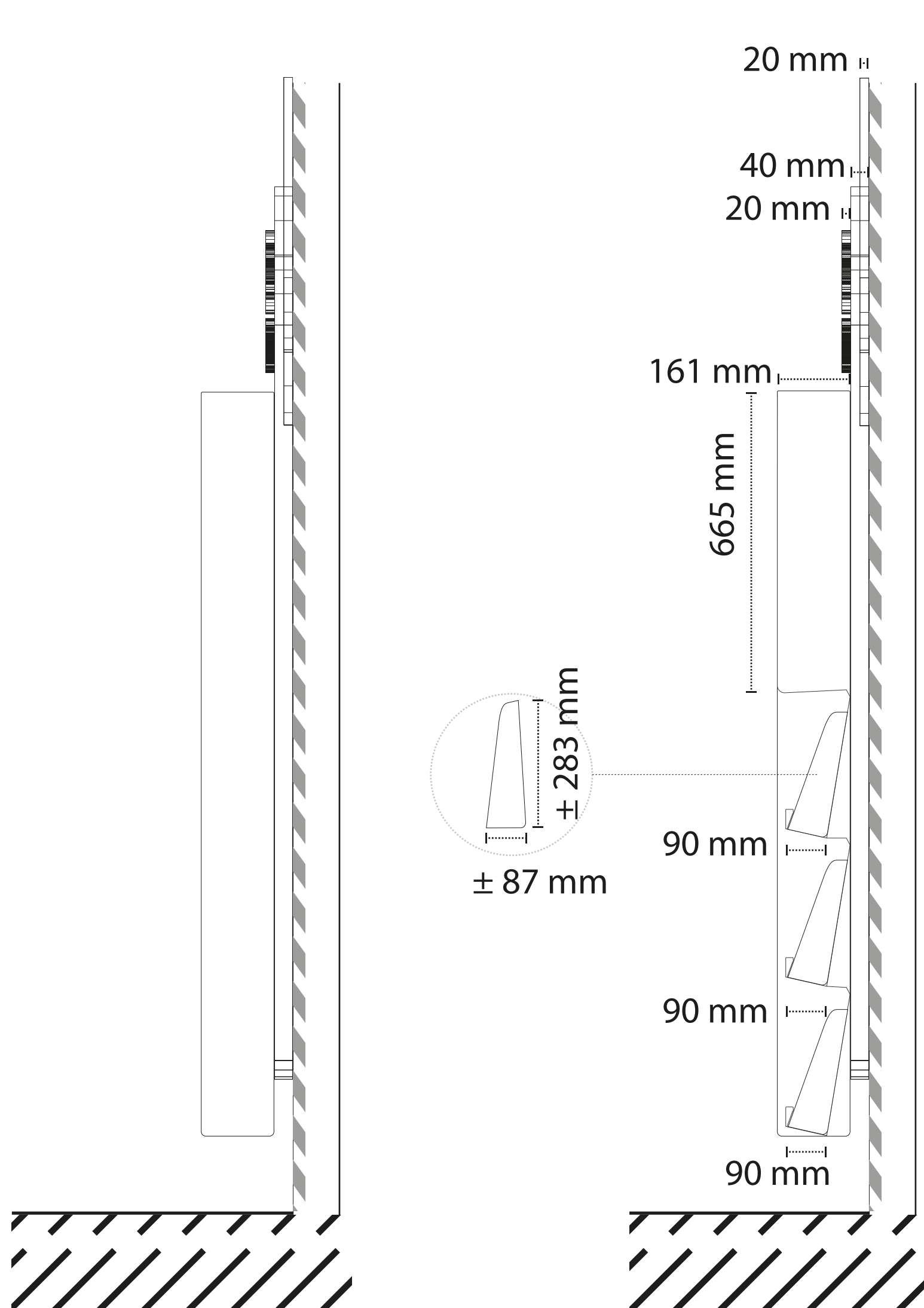

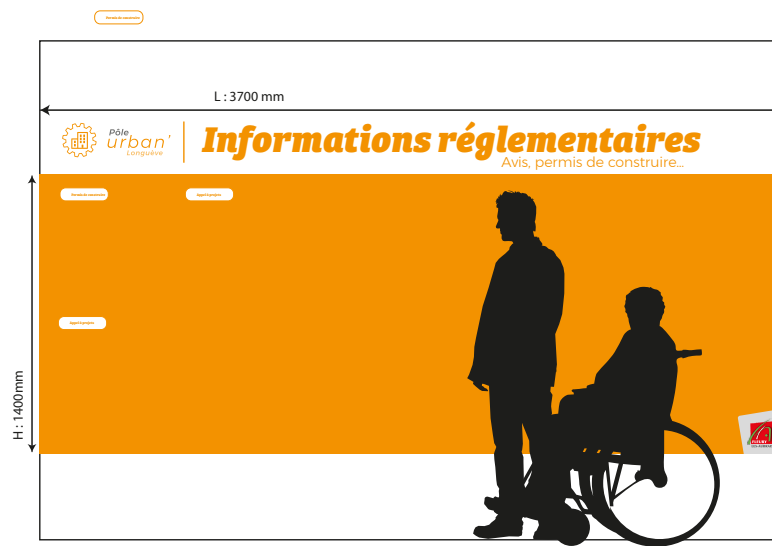

240 mm  
65 mm  
ex de magnétiques découpés

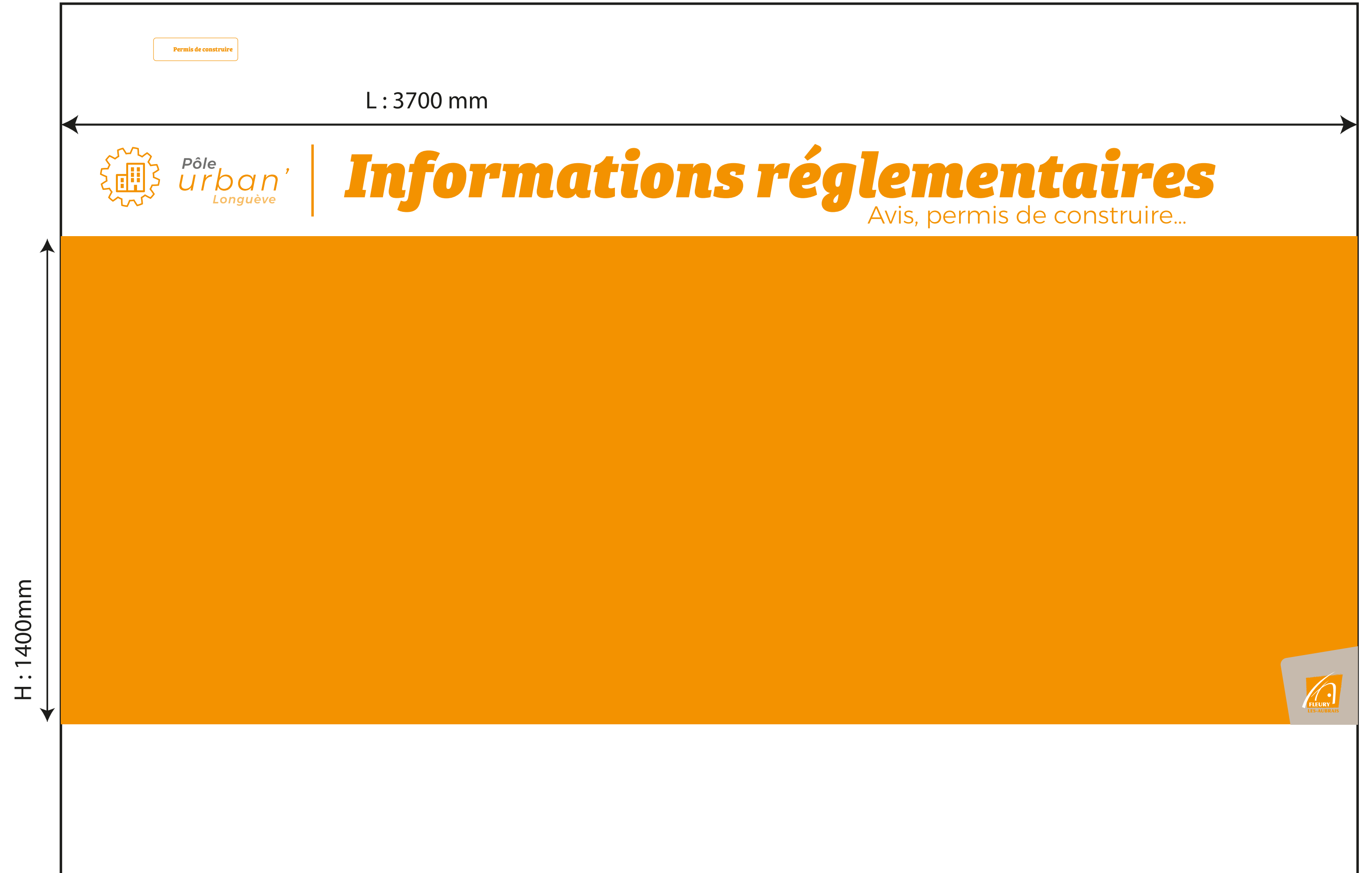

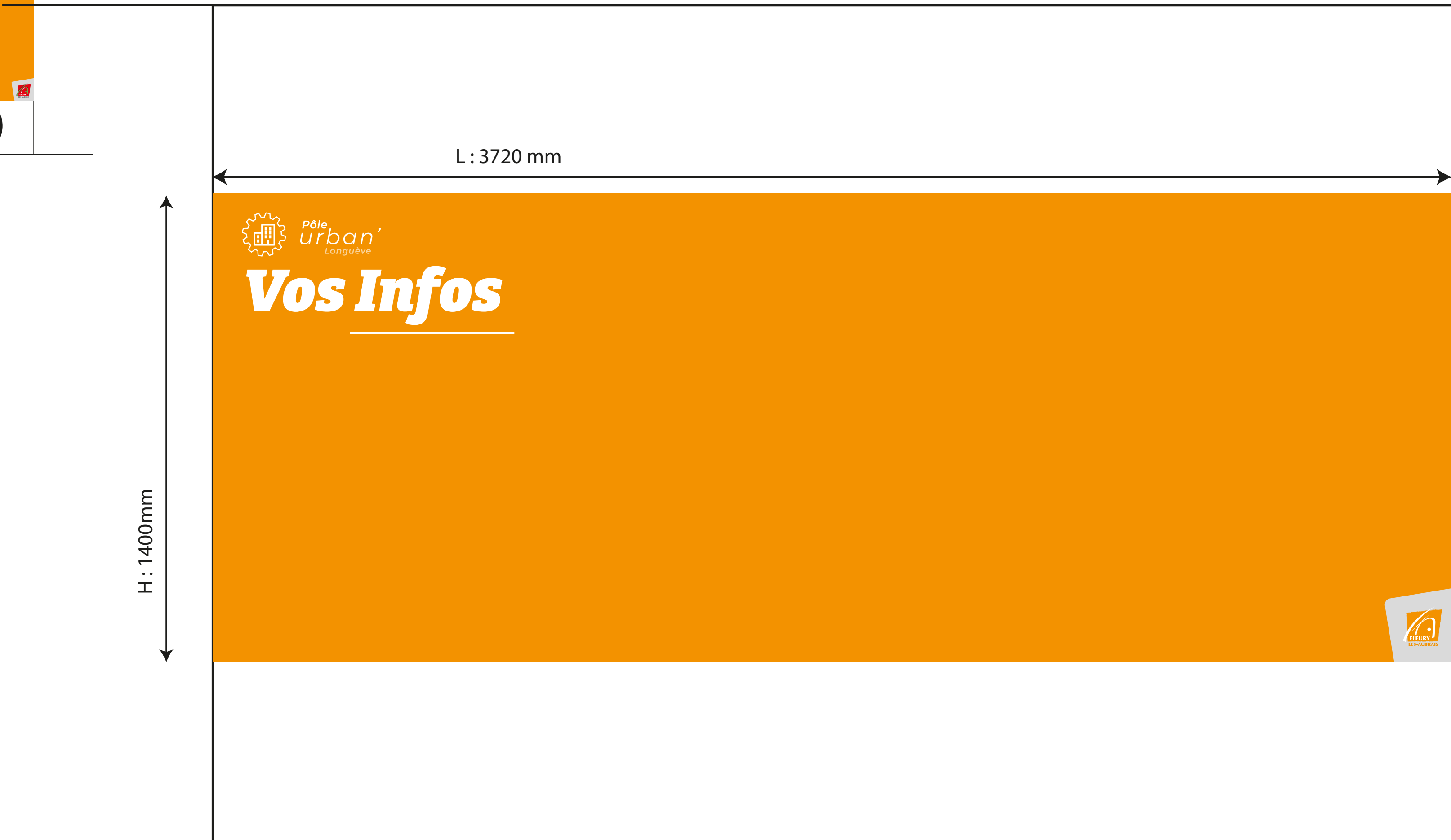



**Bienvenue !**

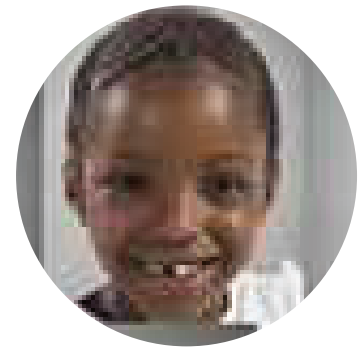

**La richesse de la solidarité naît**



**de nos différences !**



25000 mm

1760 mm

